

JBC

www.jbctools.com

Page

English 3

Español 17

Deutsch 33

中文 49



Heavy Duty station

Ref. HDE-B

Packing List

The following items should be included:

HDE Control Unit 1 unit
Ref. HDE-1B (120V)
HDE-2B (230V)
HDE-9B (100V)



Stand 1 unit
Ref. HD-SD



Heavy Duty HD Handle 1 unit
Ref. T470-B



ESD Tip Cleaner 1 unit
Ref. CL6166



Sponge 1 unit
Ref. S0354



Stand Cable 1 unit
Ref. 0011283



Power Cord 1 unit
Ref. 0010569 (230V)
0013671 (100/120V)



Manual 1 unit
Ref. 0016161



Connections

HDE Control Unit

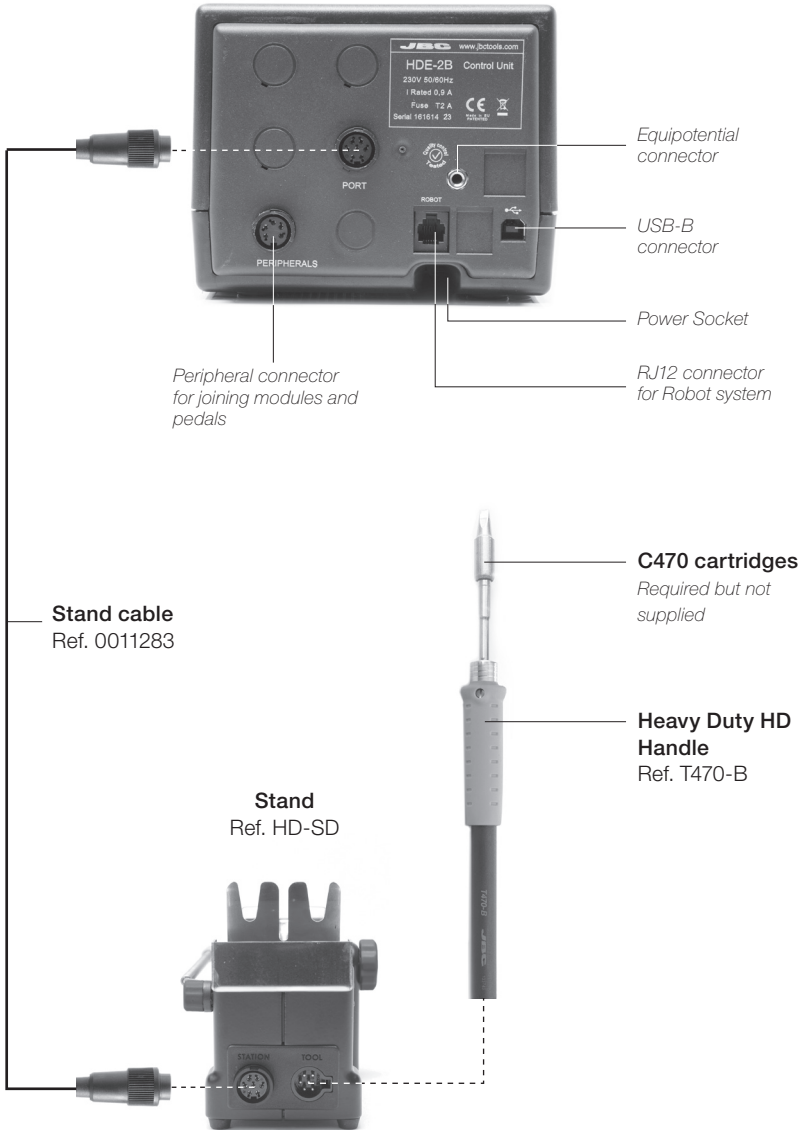

Features



Compatibility

Select the equipment that best suit your soldering or desoldering needs.

Control Unit	Stand	Tool	Cartridge Range	MNE-A	FSE-A	P-005
HDE-B	HD-SD	T470-A	C470		●	●
		T470-B			●	●
		T470-SA			●	●
		T470-ZA			●	●
		T470-FA			●	●
		T470-MC			●	●
	T470-NA			●	●	
	HDT-SD	HT470-A*			●	●
DN-SE	T470-NA**		●	●	●	

* It works with two **HDE Heavy Duty** stations in order to manage the cartridges individually

** The **MNE Nitrogen Flow Regulator** is required.

Stand



Cable collector

Keeps working area free of cable.

Quick tip changer

The cartridge extractor / inserter system permits switching cartridges without interrupting your work.

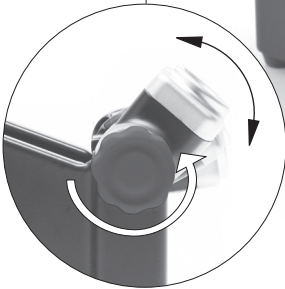
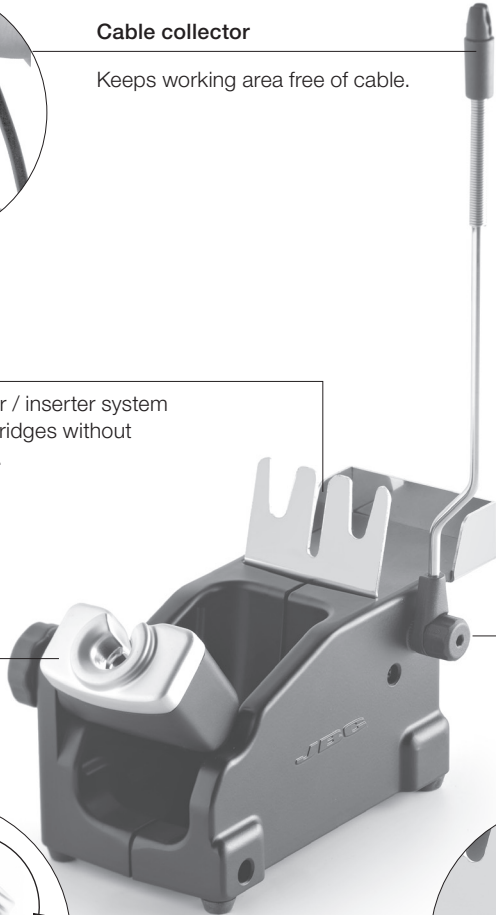

Adjustable tool holder
Suits your work position.

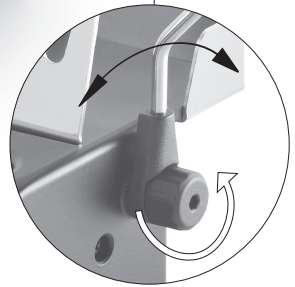

Adjustable cable collector

Tip Cleaner

Improve thermal transfer by cleaning the tip after each solder joint.

Brass Wool

Ref. CL6210

Very effective cleaning method. It leaves a small layer of solder on the tip to prevent oxidation between cleaning and reflowing.

Sponge

Ref. S0354

The least harmful cleaning method. Keep the sponge damp with distilled water when working to avoid tip wear.

Splashguard

It prevents splashing of solder particles when using the brass wool.

Non-slip base

Heavy weighted non-slip base for simple-handed cleaning.

Wiper

Ref. CL0236

A temperature resistant receptacle lets the operator remove excess solder by gently tapping or wiping.



Tapping:
Tap gently to remove excess solder.



Wiping:
Use the slots to remove remaining particles.

Optional Cleaning methods

Inox Wool

Ref. CL6205



Metal Brush

Ref. CL6220

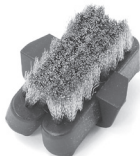

Tip-Tinner

Ref. TT-A



Sand

Ref. CL6211



Compatible Tools

T470 Handles for Heavy Duty

Use C470 Cartridge range

For intensive soldering jobs requiring continued high thermal power. They feature a non-slip-grip with a good thermal insulation and a screw which fixes the cartridge and prevents rotation.

HD Purpose Handle

Ref. T470-A



Heavy Duty HD Handle

Ref. T470-B



HD Purpose Handle with 3m cable

Ref. T470-SA

Thermal Insulator HD Handle

Ref. T470-FA



Thermal Insulator HD Handle with 3m cable

Ref. T470-MC



Tri-lobed HD Handle

Ref. T470-ZA



Nitrogen HD Handle

Ref. T470-NA

The MNE Nitrogen Flow Regulator is required. Only used with a DN-SE stand.



Nozzles

Ref. B6193
B6194
B6195

HD Thermal Tweezers

Ref. HT470-A

Only used with two HDE-B control units and a HDT-SD stand.



Note: All models are supplied with a 1.5m cable except those specified with 3m.

Changing Cartridges

1. Removing

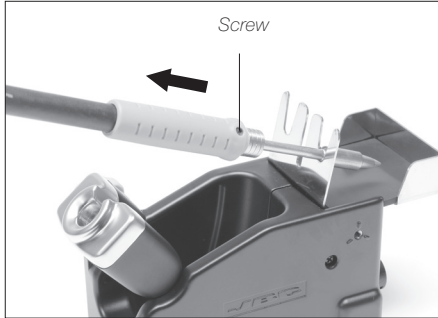

Loosen the screw. Place the Soldering Iron in the extractor and remove the cartridge.

2. Inserting

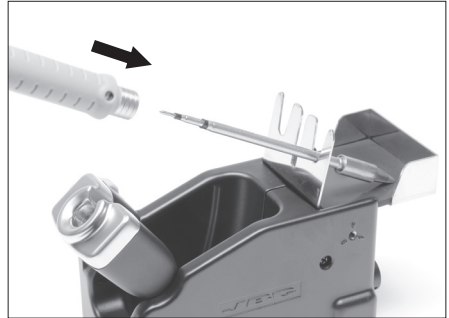

Insert the cartridge and press slightly to the mark*.

3. Fixing

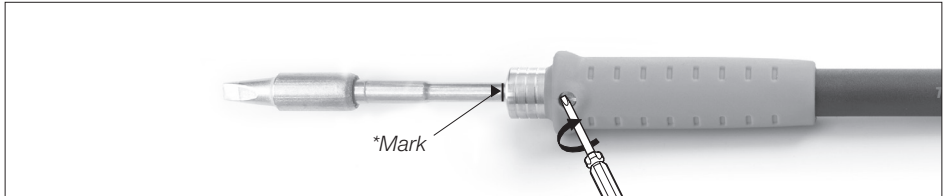

Once the cartridge is properly inserted we recommend tightening the screw to prevent it turning. Important: It is essential to insert the cartridges as far as the mark for a proper connection.

Compatible cartridges

The HDE works with T470 handles and C470 cartridges. Find the model that best suits your soldering needs in www.jbctools.com

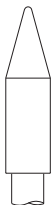

Round



Chisel



Round bent

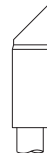

Bevel



Special models

Operation

The JBC Exclusive Heating System

This revolutionary technology is able to recover tip temperature extremely quickly. It allows the user to work at a lower temperature and improve the quality of soldering. The tip temperature is further reduced thanks to the Sleep and Hibernation modes which increase the tip life by 5.

1. Work



When the tool is lifted from the stand the tip will heat up to the selected temperature.

2. Sleep

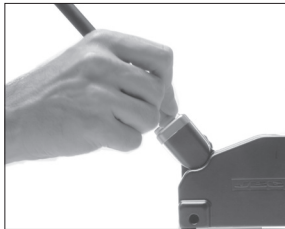

When the tool is in the stand, the temperature falls to the preset sleep temperature.

3. Hibernation



After longer periods of inactivity, the power is cut off and the tool cools down to room temperature.

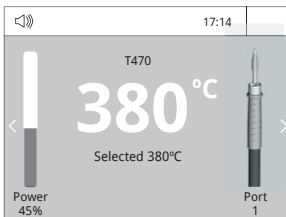

Tools Menu:

- Set temperature limits
- Select temperature levels



Tools Menu:

- Set Sleep temperature
- Set Sleep delay (from 0 to 9 min or no Sleep)

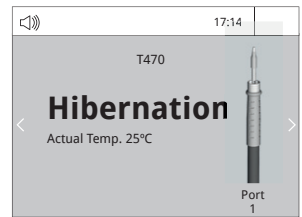

Tools Menu:

- Set Hibernation delay (from 0 to 60 min or no hibernation)

Work Screen

The HDE offers an intuitive user interface which provides quick access to station parameters.

Original PIN: 0105

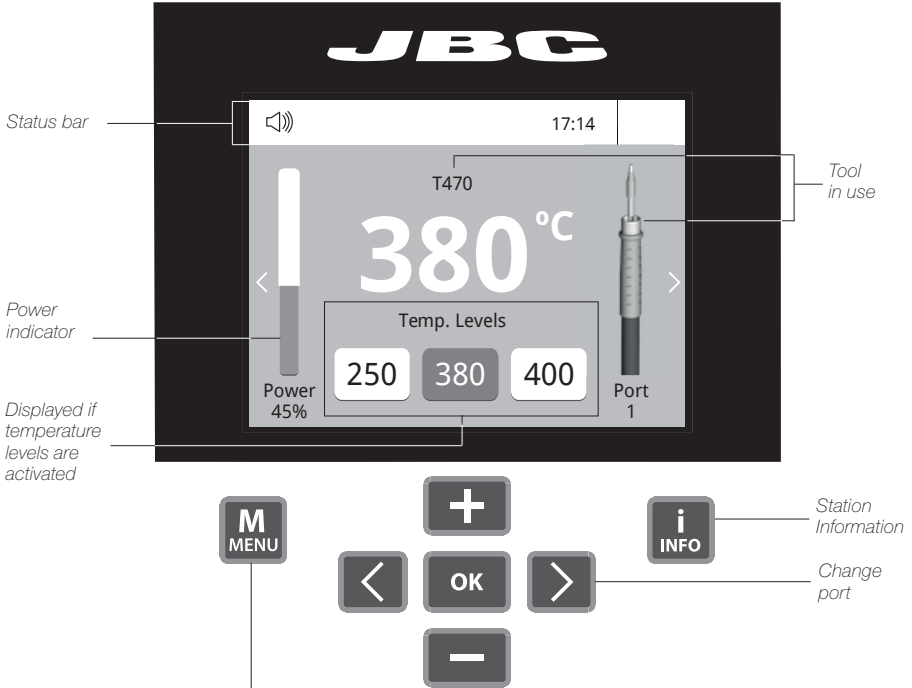

Menu Options

Press INFO for each parameter description.



Station



Tools



Counters



Peripherals



Graphics



Reset

System notifications (Status Bar)

- USB flash drive is connected.
- Station is controlled by a PC.
- Station is controlled by a robot.
- Station software update. Press INFO to start the process.
- Warning. Press INFO for failure description.
- Error. Press INFO for failure description, the type of error and how to proceed.

Process analysis



By pressing **Graphics** in the main MENU, temperature and power figures in real time are displayed for each port. This helps you decide which tip to use to obtain the best quality solder joints.

Graphics

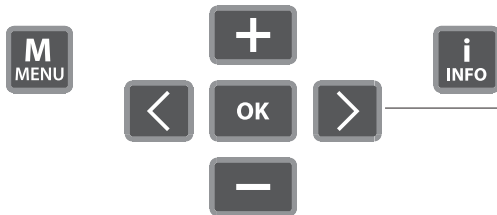
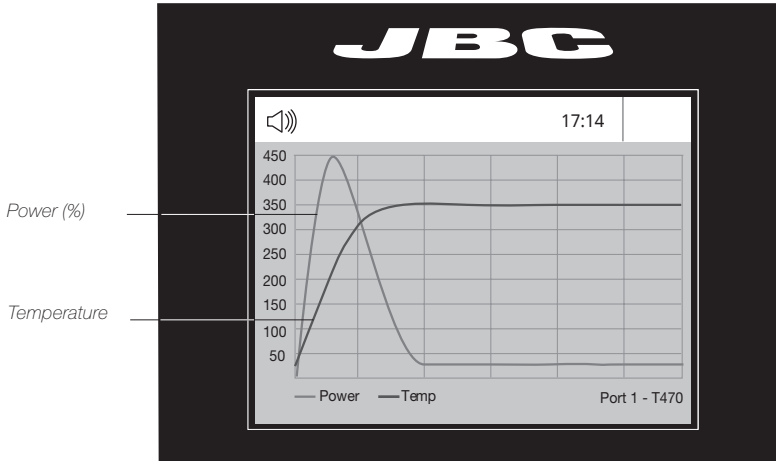

See other port graphic

Files



Files

Export graphics

Insert a USB flash drive into the USB-A connector to save your soldering process in csv format.



Soldering Net

Remotely manage and monitor as many stations as your Windows PC can handle.

1. Download the **JBC Software Manager** and the user manual from www.jbctools.com/manager.html
2. Connect the stations via USB-B connector and the PC will automatically detect them.
3. The notification  will be displayed on the station.

Functions:

- Set all the station parameters from your PC.
- Organize groups of stations and set all their parameters at the same time.
- Store specific configurations for later uses.
- Analyze the soldering graphics of the stations on your PC and export them.

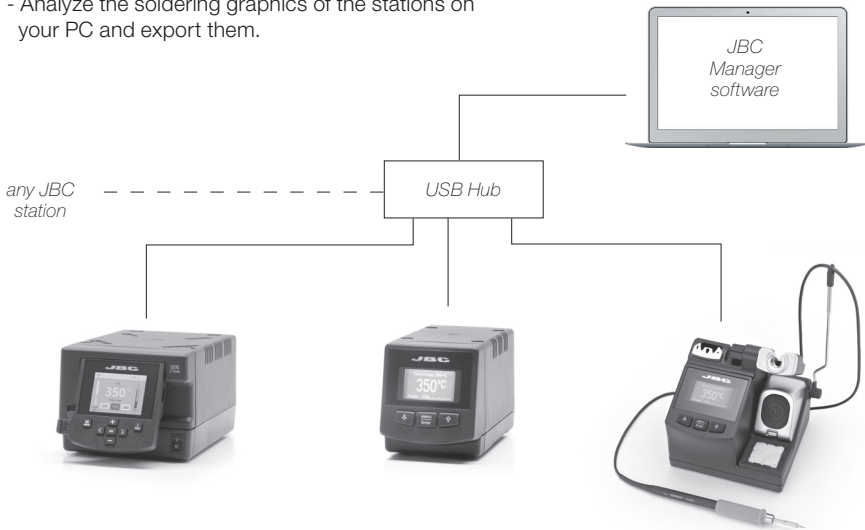

Update the station software

1. Download the JBC Update file from www.jbctools.com/software.html and save it on a USB flash drive. Preferably one with no other files.

2. Insert the USB flash drive.
The icon  is displayed while updating.



Working with Robots

Manage and monitor the station using a Robotic system.

1. Connect the tool to the station port by means of the CHB-A converter.
2. Connect your Robot system to the Robot connector (RJ12) of the station.
DB9-RJ12 Adapter available only if necessary (Ref. 0013772).
3. Enable the Robot option in the station settings and the notification will be displayed: 
4. Set your Robot's commands according to the Robot Communication Protocol, available on the website www.jbctools.com/jbcsoftware-menu-115.html.

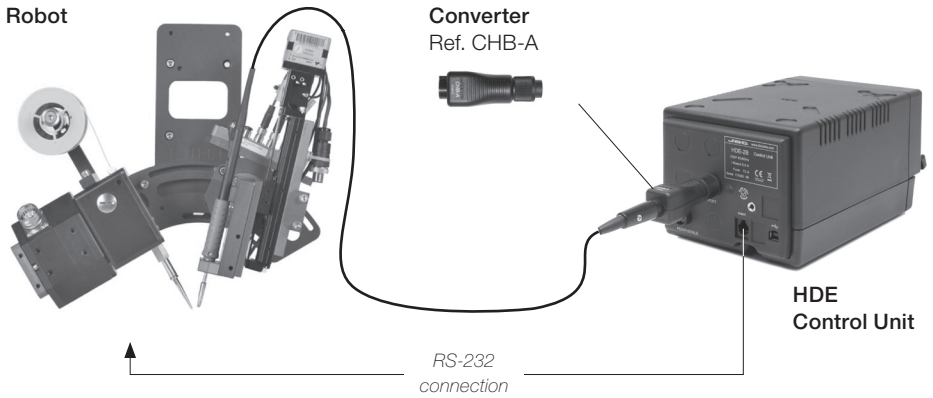

Maintenance

Before carrying out maintenance or storage, always allow the equipment to cool.

- Clean the station screen with a glass cleaner or a damp cloth.
- Use a damp cloth to clean the casing and the tool. Alcohol can only be used to clean the metal parts.
- Periodically check that the metal parts of the tool and stand are clean so that the station can detect the tool status.
- Maintain tip surface clean and tinned prior to storage in order to avoid tip oxidation. Rusty and dirty surfaces reduce heat transfer to the solder joint.
- Periodically check all cables and tubes.
- Replace a blown fuse as follows:



Clean periodically

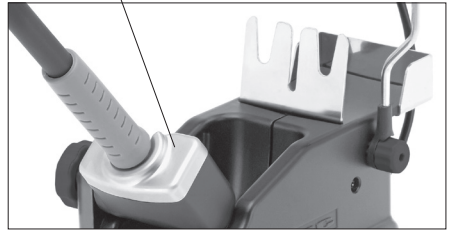

1. Pull off the fuse holder and remove the fuse. If necessary use a tool to lever it off.

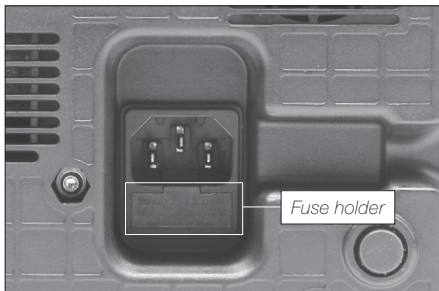

2. Press the new fuse into the fuse holder and return to the station.

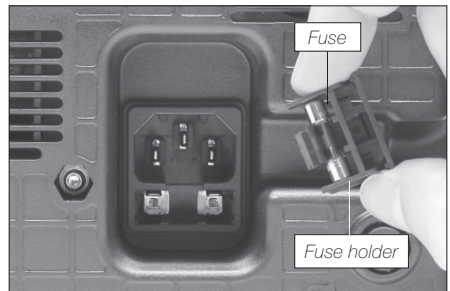

- Replace any defective or damaged pieces. Use original JBC spare parts only.
- Repairs should only be performed by a JBC authorized technical service.

Safety



It is imperative to follow safety guidelines to prevent electric shock, injury, fire or explosion.

- Do not use the units for any purpose other than soldering or rework. Incorrect use may cause fire.
- The power cord must be plugged into approved bases. Make sure that it is properly grounded before use. When unplugging it, hold the plug, not the wire.
- Do not work on electrically live parts.
- The tool should be placed in the stand when not in use in order to activate the sleep mode. The soldering tip, the metal part of the tool and the stand may still be hot even when the station is turned off. Handle with care, including when adjusting the stand position.
- Do not leave the appliance unattended when it is on.
- Do not cover the ventilation grills. Heat can cause inflammable products to ignite.
- Avoid the contact of flux with skin or eyes to prevent irritation.
- Be careful with the fumes produced when soldering.
- Keep your workplace clean and tidy. Wear appropriate protection glasses and gloves when working to avoid personal harm.
- Utmost care must be taken with liquid tin waste which can cause burns.
- This appliance can be used by children over the age of eight and also persons with reduced physical, sensory or mental capabilities or lack of experience provided that they have been given adequate supervision or instruction concerning use of the appliance and understand the hazards involved. Children must not play with the appliance.
- Maintenance must not be carried out by children unless supervised.

Specifications

HDE-1B 120V 50/60Hz. Input fuse: 4A. Output: 47V.

HDE-2B 230V 50/60Hz. Input fuse: 2A. Output: 47V.

HDE-9B 100V 50/60Hz. Input fuse: 4A. Output: 47V.

- Weight: 6,1 Kg (13.45 lb)
- Dimensions: 145 x 120 x 225 mm (5.70 x 4.72 x 8.86 in)
- Output Peak Power: 250W
- Temperature Range: 90-500 °C (190-932 °F) (±5%)
- Idle Temp. Stability (still air): ±1.5 °C (±3 °F)
- Tip to ground resistance: <2 ohms
- Tip to ground voltage: <2mV RMS
- Ambient operating temp: 10 - 40 °C (50 - 104 °F)
- Connections station-PC: USB / Peripherals connector / RJ12 connector for Robot

Complies with CE standards

ESD protected housing "skin effect"

Estación de alta potencia

Ref. HDE-B

Composición

Los siguientes artículos deben estar incluidos:

HDE Control Unit

HDE Unidad de Control 1 unidad

Ref. HDE-1B (120V)
HDE-2B (230V)
HDE-9B (100V)



Stand

Soporte 1 unidad

Ref. HD-SD



Heavy Duty HD Handle

Mango HD de uso intensivo 1 unidad
Ref. T470-B



ESD Tip Cleaner

Limpiador de puntas ESD 1 unidad
Ref. CL6166



Sponge

Esponja 1 unidad
Ref. S0354



Stand Cable

Cable del soporte 1 ud.
Ref. 0011283



Power Cord

Cable de red 1 ud.
Ref. 0010569 (230V)
0013671 (100/120V)



Manual 1 unidad

Ref. 0016161



Heavy Duty station
Ref. HDE-B

Conexiones

HDE Control Unit *HDE Unidad de Control*

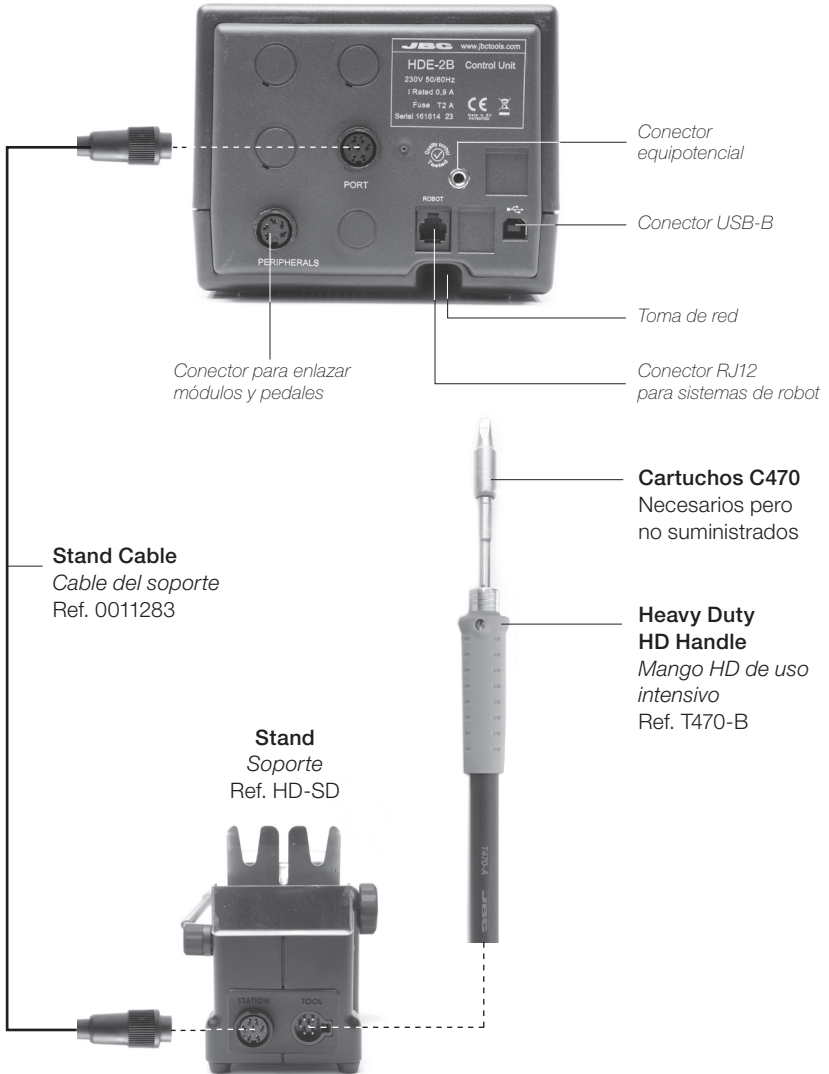

Características



Compatibilidades

Seleccione los equipos que más se adapten a sus necesidades de soldadura.

Unidad de Control	Soporte	Herramientas	Gama de cartuchos	MNE-A	FSE-A	P-005
HDE-B	HD-SD	T470-A	C470		●	●
		T470-B			●	●
		T470-SA			●	●
		T470-ZA			●	●
		T470-FA			●	●
		T470-MC			●	●
		T470-NA			●	●
	HDT-SD	HT470-A*			●	●
DN-SE	T470-NA**	●	●	●		

* Necesita **2 Unidades HDE** para poder controlar cada cartucho individualmente.

** Se requiere el **Regulador de Flujo de Nitrógeno MNE**.

Soporte ajustable



Recogecable

Reduce las molestias del cable y mantiene el área de trabajo ordenada

Cambio rápido de cartuchos

Cambie cartuchos sin interrumpir su trabajo

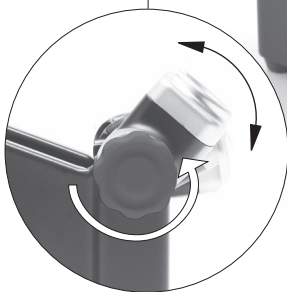
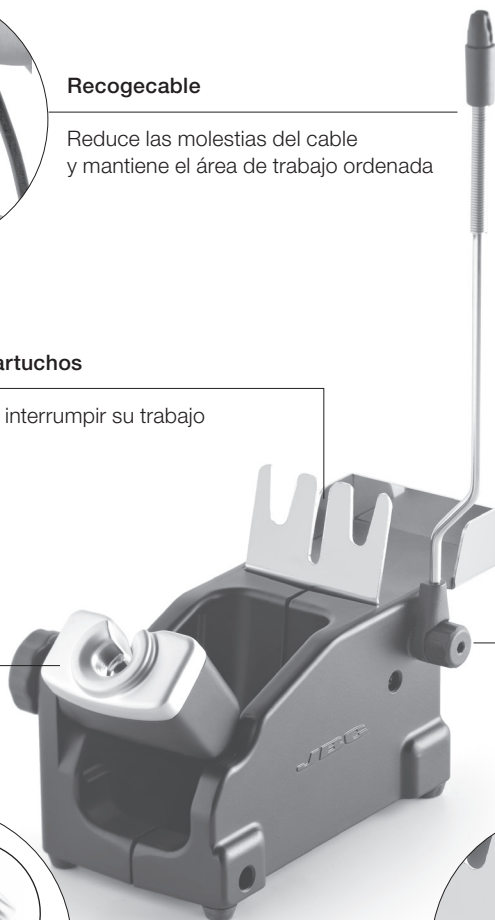

Soporte de herramienta ajustable
Se adapta a su posición de trabajo

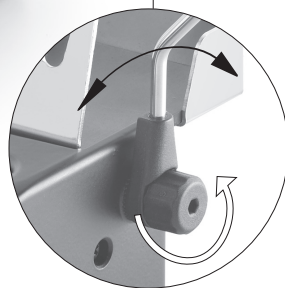

Recogecable ajustable

Limpiador de Puntas

Mejore la transferencia térmica de la punta limpiándola después de cada soldadura.

Brass Wool

Lana de latón
Ref. CL6210

Método de limpieza muy efectivo. Deja una fina capa de soldadura en la punta para prevenir la oxidación hasta el siguiente uso.

Sponge

Esponja
Ref. S0354

El método de limpieza más eficaz y menos dañino. Mantenga la esponja húmeda con agua destilada, así evitará el desgaste de la punta.

Splashguard

Protección anti-salpicaduras

Previene las salpicaduras de partículas de soldadura.

Non-slip base

Base antideslizante

No es necesario sujetar la base al limpiar.

Wiper

Limpiador
Ref. CL0236

Receptáculo resistente a la temperatura que permite al usuario eliminar el exceso de soldadura golpeando la punta suavemente. Se puede extraer fácilmente para su limpieza.



Golpeteo:

Golpee suavemente para retirar el exceso de soldadura.



Limpieza:

Use las ranuras para retirar las partículas restantes.

Sistemas de limpieza opcionales

Inox Wool

Lana inoxidable
Ref. CL6205

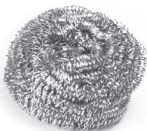

Metal Brush

Cepillos de metal
Ref. CL6220

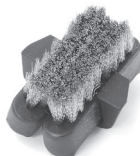

Tip-Tinner

Reestañador de puntas
Ref. TT-A



Sand

Arena
Ref. CL6211



Herramientas compatibles

Mangos para aplicaciones de alta demanda térmica

Utiliza la gama de cartuchos C470

Para trabajos de soldadura intensivos que requieran una alta potencia térmica continuada. Estos modelos cuentan con una empuñadura anti-deslizante, con aislamiento térmico y con un tornillo que fija el cartucho para prevenir su rotación y movimiento.

HD Purpose Handle

Mango HD
Ref. T470-A



Heavy Duty HD Handle

Mango HD de uso intensivo
Ref. T470-B



HD Purpose Handle with 3m cable

Mango HD con cable de 3m
Ref. T470-SA

Thermal Insulator HD Handle

Mango HD con aislamiento térmico
Ref. T470-FA



Thermal Insulator HD Handle with 3m cable

Mango HD con aislamiento térmico con cable de 3m
Ref. T470-MC



Tri-lobed HD Handle

Mango HD trilobular
Ref. T470-ZA



Nitrogen HD Handle

Mango HD con aporte de nitrógeno
Ref. T470-NA

Se requiere un regulador de caudal de nitrógeno MNE y un soporte DN-SE.

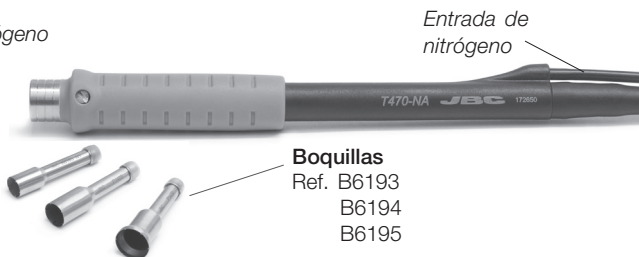

HD Thermal Tweezers

Pinza HD
Ref. HT470-A

Se requieren dos unidades de control HDE-B y un soporte HDT-SD.



Nota: Todos los modelos se suministran con 1,5m de cable excepto aquellos especificados con 3m.

Cambiar cartuchos

1. Retirar

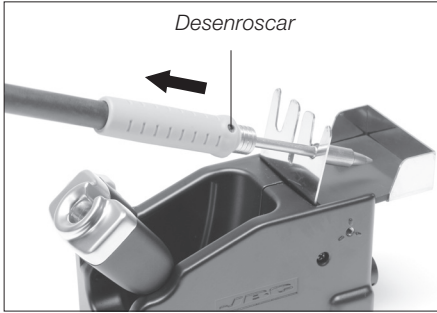

Desenrosque el tornillo. Coloque el soldador en el extractor y tire para retirar el cartucho.

2. Insertar

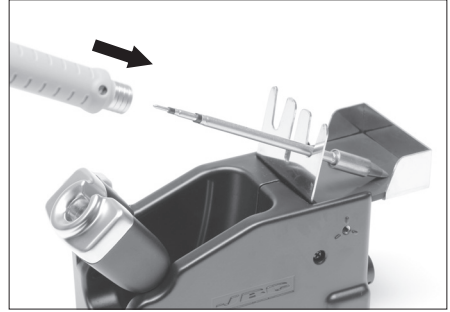

Inserte el nuevo cartucho presionando ligeramente hasta la marca*.

3. Fijar

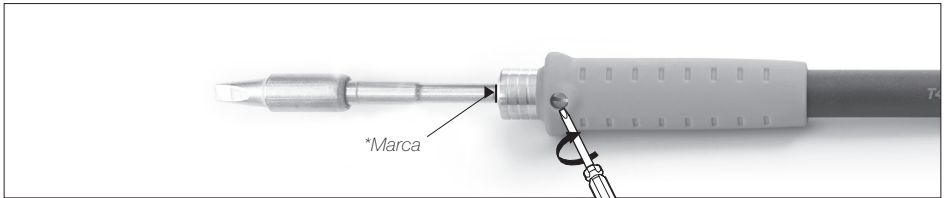

Una vez el cartucho se ha insertado correctamente, enrosque el tornillo para fijarlo.
Importante: Es necesario insertar el cartucho hasta la marca para una conexión correcta.

Cartuchos compatibles

La HDE funciona con mangos T470 y cartuchos C470. Encuentre el modelo que mejor se adapte a sus necesidades de soldadura en www.jbctools.com

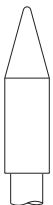

Redondo



Cinzel



Redondo
curvado



Bisel



Modelos
especiales

Funcionamiento

El Exclusivo Sistema Calefactor de JBC

Nuestra tecnología revolucionaria es capaz de recuperar la temperatura de la punta de forma extremadamente rápida. Esto significa que el usuario puede trabajar a una temperatura más baja y mejorar la calidad de la soldadura. Esta temperatura se reduce aún más gracias a los modos de Sleep e Hibernación que incrementan hasta 5 veces la vida de las puntas.

1. Trabajo



Al levantar la herramienta del soporte, la punta se calienta hasta la temperatura seleccionada.

2. Sleep

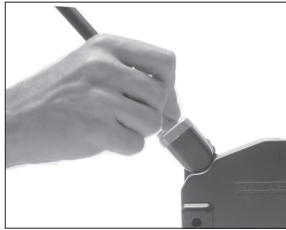

Cuando la herramienta está en el soporte, la temperatura se reduce a la temperatura de Sleep predefinida.

3. Hibernación



Tras largos períodos de inactividad, se corta el suministro de energía y la punta se enfría hasta temperatura ambiente.

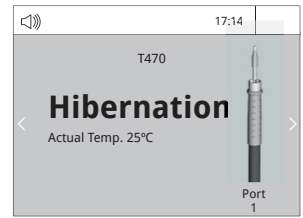
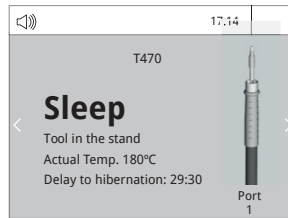
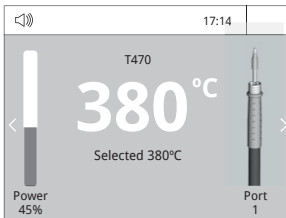

Menú Tools:

- Configure límites de temperatura.
- Seleccione niveles de temperatura.

Menú Tools:

- Configure la temperatura de Sleep
- Configure el tiempo de retraso de Sleep (de 0 a 9 min o ninguno)

Menú Tools:

- Configure el retraso de Hibernación (de 0 a 60 min o ninguno)

Pantalla de trabajo

La HDE-B presenta una **interfaz de usuario intuitiva** y ofrece un **rápido acceso** a los parámetros.

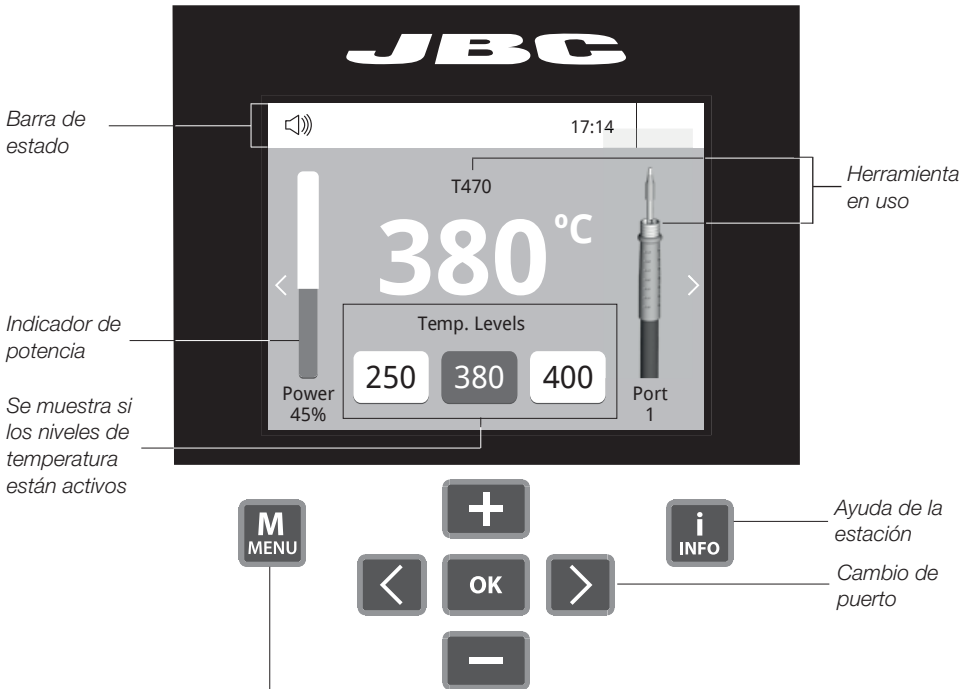

Barra de estado

Indicador de potencia

Se muestra si los niveles de temperatura están activos

Herramienta en uso

Ayuda de la estación

Cambio de puerto

Opciones de Menú

Pulse INFO para la descripción de parámetros.



Station



Tools



Counters



Peripherals



Graphics



Reset

Notificaciones (Barra de estado)

- Unidad de memoria USB conectada.
- Estación controlada por un PC.
- Estación controlada por un robot.
- Actualización del software de la estación. Pulse INFO para iniciar el proceso.
- Aviso. Pulse INFO para la descripción del fallo.
- Error. Pulse INFO para la descripción del fallo, el tipo de error y cómo proceder.

Análisis del proceso



Graphics

Pulsando sobre **Graphics** en el menú principal, se muestran las respuestas de temperatura y potencia en tiempo real de cada puerto. Esto le ayudará a decidir cuál es la punta más adecuada para obtener la mejor calidad en sus soldaduras.

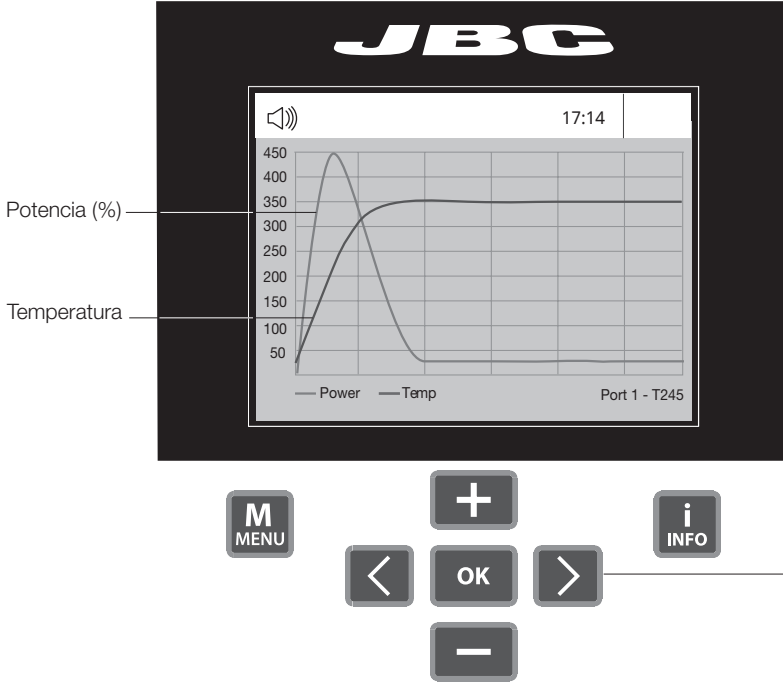

Archivos

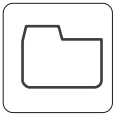

Files

Exporte gráficos
Inserte una unidad de memoria USB para guardar su proceso de trabajo en formato csv.



Red de soldadura

Gestione y monitorice tantas estaciones como soporte su PC.

1. Descargue el software **JBC Manager** y el manual de usuario de www.jbctools.com/manager.html
2. Conecte las estaciones a través del conector USB-B y el PC las detectará automáticamente.
3. La notificación  se mostrará en la estación.

Funciones:

- Configure todos los parámetros de la estación desde su PC.
- Organice grupos de estaciones y configure todos sus parámetros al mismo tiempo.
- Guarde configuraciones específicas para usos posteriores.
- Analice gráficos del proceso de soldadura de las estaciones desde su PC y expórtelos.

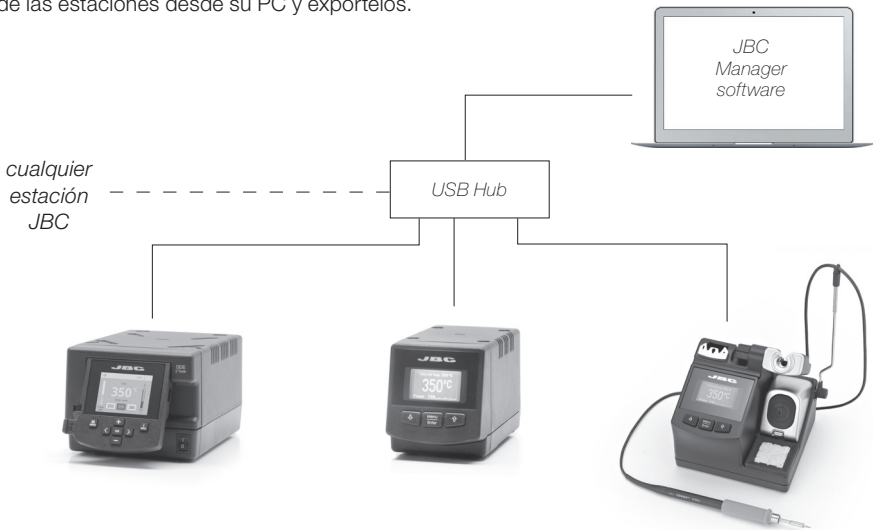

Actualice el software de la estación

1. Descargue el archivo de actualización de www.jbctools.com/software.html y guárdelo en una unidad de memoria USB (preferentemente una sin otros archivos).
2. Inserte la unidad de memoria USB. La notificación  se muestra mientras se actualiza el software.



Trabajar con Robots

Gestione y monitorice la estación por medio de un sistema robotizado.

1. Conecte la herramienta a la estación utilizando el convertidor CHB-A.
2. Conecte su sistema robotizado al conector Robot de la estación (RJ12).
Si lo necesita, el adaptador DB9-RJ12 puede encontrarlo con la referencia Ref. 0013772.
3. Active la opción de robot en la estación y se mostrará la siguiente notificación: 
4. Configure su sistema robotizado según el Protocolo de Comunicación para Robots, que encontrará en www.jbctools.com/jbcsoftware-menu-115.html.

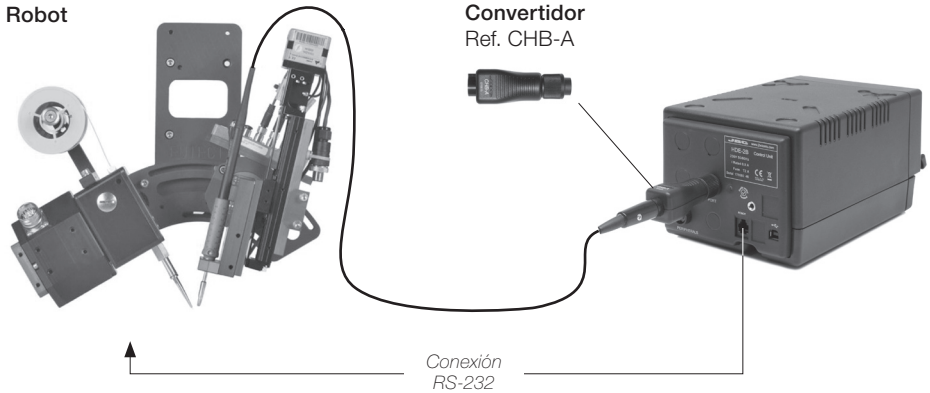

Mantenimiento

Antes de realizar tareas de mantenimiento o almacenar, desconecte el equipo y déjelo enfriar.

- Limpie la pantalla de la estación con un paño húmedo.
 - Use un paño húmedo para limpiar la pantalla del equipo, la carcasa y la herramienta. Puede utilizar alcohol solamente en las partes metálicas.
 - Mantenga la punta limpia y estañada la para evitar su oxidación. Las superficies sucias reducen la transferencia térmica a la soldadura.
 - Revise periódicamente los tubos y cables.
- Cambie el fusible fundido de la siguiente manera:



Limpiar periódicamente

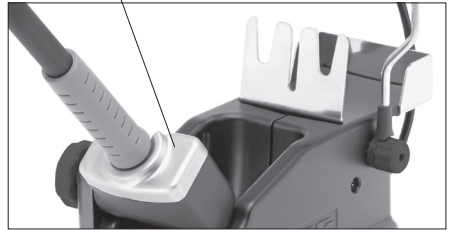

1. Tire del portafusible para retirar el fusible. Si lo precisa, utilice una pequeña palanca.

2. Sustituya el fusible y coloque de nuevo el portafusibles en su sitio.

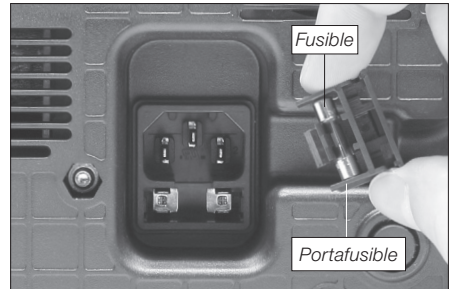
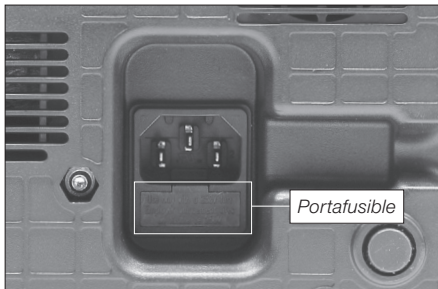

- Cambie cualquier pieza defectuosa o dañada. Utilice solamente recambios originales de JBC.
- Cualquier reparación sólo se podrá realizar por un servicio técnico oficial JBC.

Seguridad



Es necesario cumplir estas normas de seguridad para prevenir cualquier choque eléctrico, heridas, fuego o explosiones.

- No utilice el equipo para otros fines que no sea la soldadura o reparación. El uso incorrecto puede causar fuego.
- El cable de red debe enchufarse en bases homologadas. Asegúrese de que está conectado a tierra correctamente antes de su uso. Al retirarlo, tire del conector, no del cable.
- No trabaje con tensión.
- La herramienta debe permanecer en el soporte mientras no está en uso con el fin de activar el modo de Sleep o Hibernación. El cartucho y las partes metálicas de la herramienta o del soporte pueden estar calientes incluso con la estación apagada. Manipule con cuidado, incluso cuando se ajusta la posición del soporte.
- No deje el aparato desatendido cuando está en funcionamiento.
- No cubra las rejillas de ventilación. El calor puede causar que los productos inflamables se enciendan.
- Evite el contacto del Flux con la piel o los ojos para prevenir la irritación.
- Tenga cuidado con el humo producido al trabajar.
- Mantenga su lugar de trabajo limpio y ordenado. Use gafas y guantes de protección adecuados. Así evitará cualquier daño.
- Tenga cuidado con los restos de estaño líquido. En contacto con la piel, puede causar quemaduras.
- Este aparato puede ser utilizado por personas a partir de 8 años y también por aquellas personas con movilidad reducida o capacidades físicas, sensoriales o mentales limitadas o con falta de experiencia y conocimientos siempre y cuando reciban supervisión o instrucciones relativas al uso del aparato de una manera segura y entiendan los riesgos que implica. Los niños no deben jugar con el aparato.
- Los niños no deberán realizar tareas de mantenimiento sin supervisión.

Specificaciones

HDE-1B 120V 50/60Hz. Fusible de entrada: 4A. Salida: 47V.

HDE-2B 230V 50/60Hz. Fusible de entrada: 2A. Salida: 47V.

HDE-9B 100V 50/60Hz. Fusible de entrada: 4A. Salida: 47V.

- | | |
|---|---|
| - Peso: | 6,1 Kg (13.45 lb) |
| - Dimensiones: | 145 x 120 x 225 mm (5.70 x 4.72 x 8.86 in) |
| - Potencia máxima: | 250 W |
| - Rango de temperatura: | 90-500 °C (190-932 °F) (±5%) |
| - Estabilidad de temperatura en reposo: | ±1.5 °C (±3 °F) |
| - Resistencia punta a tierra: | <2 ohms |
| - Tensión en punta: | <2mV RMS |
| - Temperatura ambiente de trabajo: | 10 - 40 °C (50 - 104 °F) |
| - Conexiones estación-PC | USB / Peripherals connector
RJ12 connector for Robot |

Complies with CE standards
ESD protected housing "skin effect"

Hochleistungs-Station

Ref. HDE-B

Packliste

Die folgenden Artikel sollten enthalten sein:

HDE Control Unit

HDE Steuereinheit 1 Stück

Ref. HDE-1B (120V)
HDE-2B (230V)
HDE-9B (100V)



Stand

Ablageständer 1 Stück

Ref. HD-SD



Heavy Duty HD Handle

HD Handstück 1 Stück

Ref. T470-B



ESD Tip Cleaner

ESD Spitzenreinigungs-

system 1 Stück

Ref. CL6166



Sponge

Schwamm 1 Stück

Ref. S0354



Stand Cable

Ablageständerkabel .. 1 Stück

Ref. 0011283



Power Cord

Netzkabel 1 Stück

Ref. 0010569 (230V)
0013671 (100/120V)



Handbuch 1 Stück

Ref. 0016161



Anschluss

HDE Control Unit HDE Steuereinheit

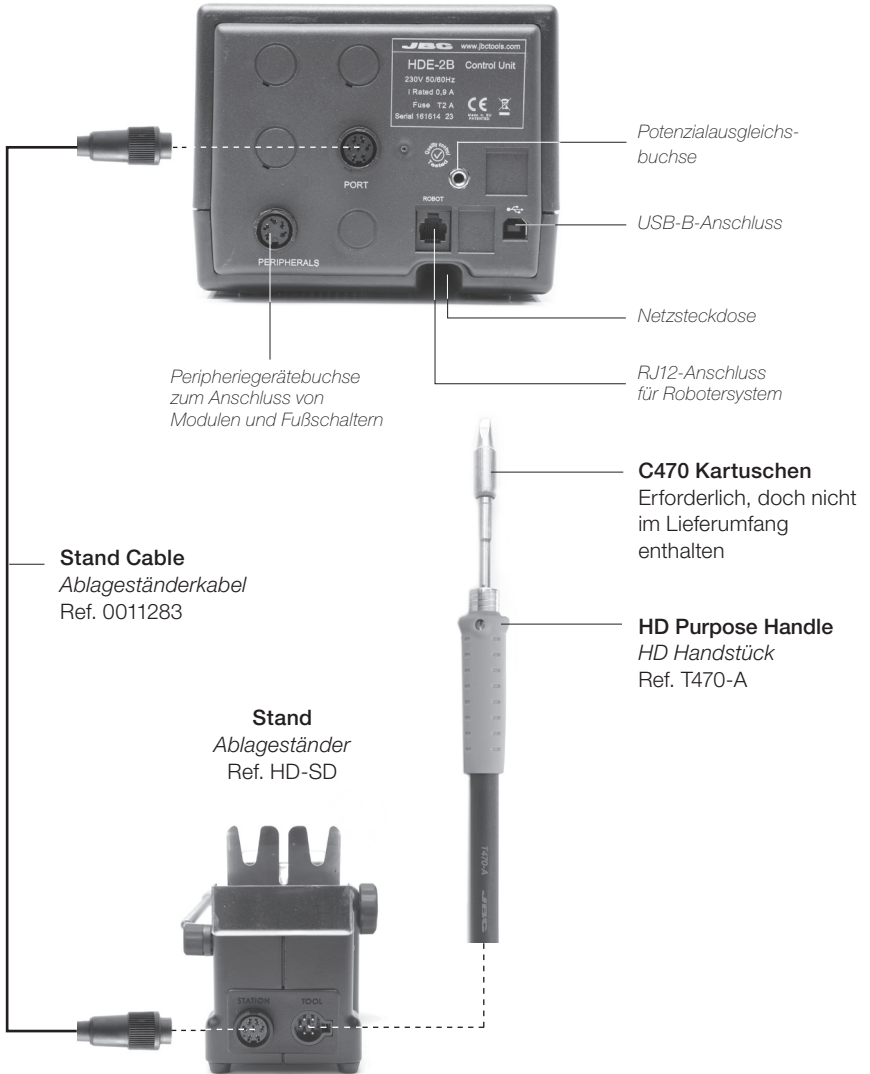

Merkmale

2,8" Farb TFT Bildschirm

USB-A-Anschluss



Das Display zum einfachen Ablesen kippen

Kompatibilität

Wählen Sie die Ausrüstung nach Ihren Lötbedürfnisse aus.

Steuereinheit	Ständer	Werkzeug	Kartuschen	MNE-A	FSE-A	P-005
HDE-B	HD-SD	T470-A	C470		●	●
		T470-B			●	●
		T470-SA			●	●
		T470-ZA			●	●
		T470-FA			●	●
		T470-MC			●	●
	T470-NA			●	●	
	HDT-SD	HT470-A*			●	●
DN-SE	T470-NA**		●	●	●	

* Sie benötigen **2 Lötseinheiten HDE** um die Lötkartuschen der HT470-A einzeln zu steuern.

** Für den T470-NA wird der Durchflussregler für **Stickstoff MNE** erforderlich.

Verstellbare Ablage



Kabelausleger

Sorgt für einen kabelfreien Arbeitsbereich.

Spitzen-Schnellwechsler

Das Kartuschen Abzieher-Einsetz-System ermöglicht den Kartuschenwechsel ohne Unterbrechung Ihrer Arbeit.

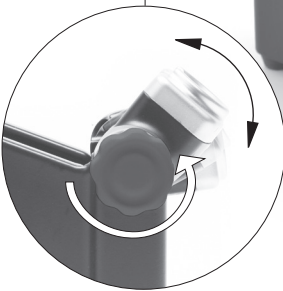
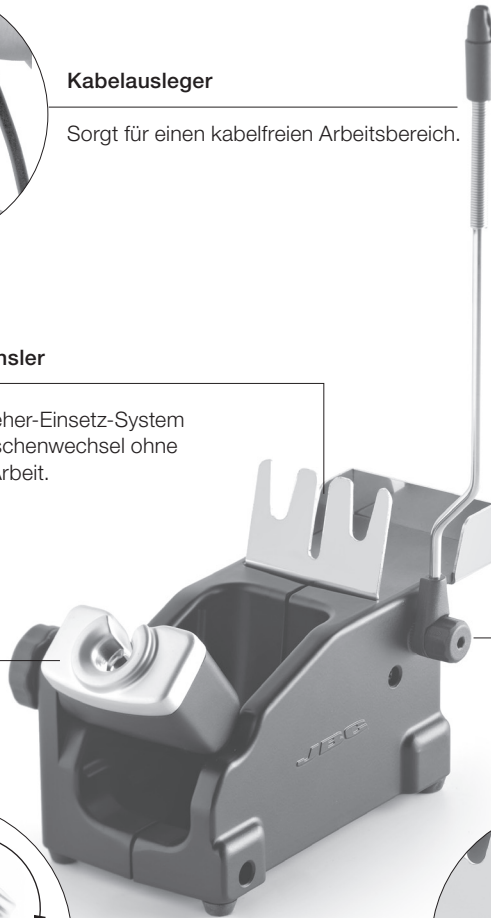

Verstellbarer Werkzeughalter
Optimiert Ihre Arbeitsposition.

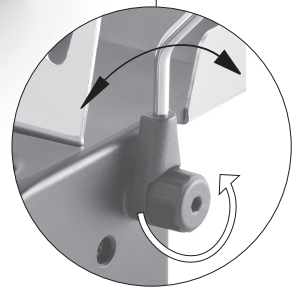

Verstellbare Kabelausleger

Spitzenreinigungssystem

Verbessern Sie die Wärmeübertragung durch Reinigung der Spitze nach jeder Lötverbindung.

Brass Wool *Messingwolle*
Ref. CL6210

Sehr effektive Reinigungsmethode. Hinterlässt eine dünne Schicht von Lötzinn auf die Spitze, um die Oxidation zwischen Reinigung und Wiederbenetzung zu verhindern

Sponge *Schwamm*
Ref. S0354

Die schonendste Reinigungsmethode. Halten Sie den Schwamm bei der Arbeit mit destilliertem Wasser feucht, um Spitzenverschleiß zu vermeiden.

Splashguard
Spritzschutz

Minimiert Lötmittelspritzer beim Einsatz von Messinggeflecht.

Wiper *Spitzenabstreifer*
Ref. CL0236

Ein temperaturbeständiger Behälter ermöglicht es dem Werker, durch vorsichtiges Abklopfen oder Abstreifen überschüssiges Lot zu entfernen. Er kann zur Reinigung leicht herausgenommen werden.

Non-slip base
Rutschfester Ständer

Ständer muss bei Spitzenreinigung nicht festgehalten werden.



Abklopfen:
Klopfen Sie vorsichtig ab, um überschüssiges Lot zu entfernen.



Abstreifen:
Benutzen Sie die Aussparungen, um noch vorhandene Partikel zu entfernen.

Wahlweise

Inox Wool
Edelstahlwolle
Ref. CL6205



Metal Brush
Metallbürste
Ref. CL6220

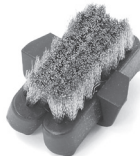

Tip-Tinner
Spitzenverzinner
Ref. TT-A



Sand
Ref. CL6211



Heavy Duty Anschlussmöglichkeiten

T-470 LötKolben für hohe Belastungen

Kartuschen-Sortiment C470 benutzen

Für intensive Lötaufträge, die ständig hohe Temperaturanforderungen stellen. Sie verfügen über einen rutschfesten Griff mit einer guten Wärmeisolierung und einer Schraube, die die Kartusche fixiert und Rotation verhindert.

HD Purpose Handle

HD Handstück
Ref. T470-A



Heavy Duty HD Handle

HD Handstück
Ref. T470-B



HD Purpose Handle with 3m cable

HD Handstück mit Kabel 3m
Ref. T470-SA

Thermal Insulator HD Handle

Wärmeisoliertes HD Handstück
Ref. T470-FA



Thermal Insulator HD Handle with 3m cable

Wärmeisoliertes Handstück mit Kabel 3m
Ref. T470-MC



Tri-lobed HD Handle

Dreilappiges Handstück
Ref. T470-ZA



Nitrogen HD Handle

HD Handstück mit Stickstoff Eingang
Ref. T470-NA

Der Einsatz des
LötKolbens T470-NA
erfordert einen Lötständer
DN-SE.



Düsen

Ref. B6193
B6194
B6195

HD Thermal Tweezers

HD Entlötpinzette
Ref. HT470-A

Der Einsatz der Pinzetten HT470-A
erfordert zwei Steuerungseinheiten
HDE-B und einen Lötständer
HDT-SD.

Hinweis:



Alle Modelle werden mit einem 1,5m langen Kabel ausgeliefert außer diejenigen, bei denen 3m spezifiziert ist.

Auswechseln der Kartuschen

1. Entfernen

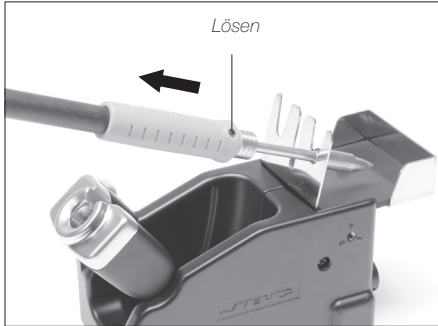

Die Schraube lösen. LötKolben im Abzieher positionieren und die Kartusche entfernen.

2. Einsetzen

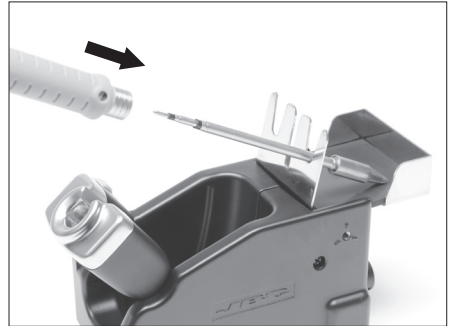

Die Kartusche einsetzen und mit leichtem Druck bis zur Markierung*.

3. Fixieren

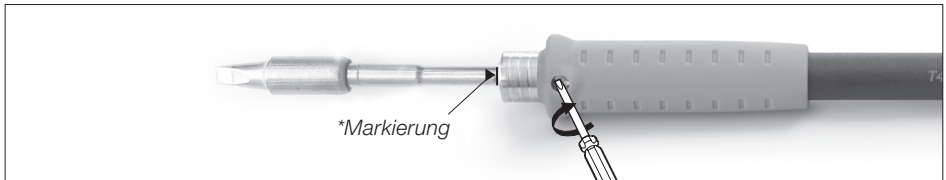

Sobald die Kartusche korrekt eingesetzt ist, empfehlen wir die Schraube festzuziehen, um Bewegung zu verhindern.

Wichtig: Es ist wichtig, die Kartuschen für eine einwandfreie Verbindung genau bis zur Markierung einzustecken.

Kompatible Kartuschen

Die HDE arbeitet mit T470-Handstücken und C470-Kartuschen. Finden Sie das passende Modell für Ihren Lötbedarf unter www.jbctools.com

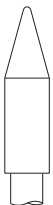

Rund



Meißelförmig



Rund gebogen



Abgeschrägt



Spezialmodelle

Betrieb

Das exklusive Heizsystem von JBC

Diese revolutionäre Technik ist dazu in der Lage, außerordentlich schnell die Spitzentemperatur zu erreichen. Dies ermöglicht es dem Benutzer, mit einer niedrigeren Temperatur zu arbeiten. Daraus ergibt sich eine fünfmal längere Spitzenzeit.

3. Überwinterung

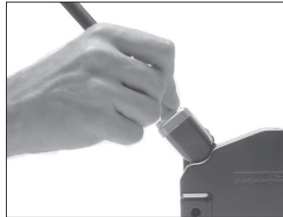

1. Arbeit

Nehmen Sie das Werkzeug aus der Ablage und die Werkzeugschmelze wird auf die gewählte Temperatur aufgeheizt.



2. Sleep

Wenn sich das Werkzeug in der Ablage befindet, wird die Temperatur auf voreingestellte Sleep-Temperatur abgesenkt.



Nach längeren Zeiträumen der Untätigkeit wird die Stromversorgung abgeschaltet und das Werkzeug kühlt auf Raumtemperatur ab.

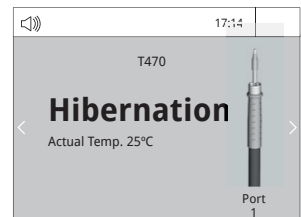
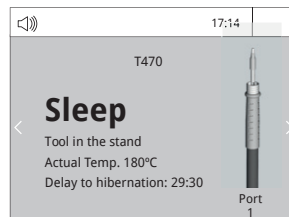
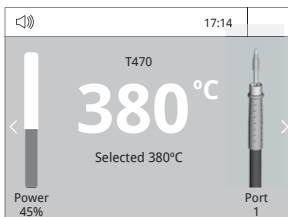

Menü Tools:

- Temperaturgrenzwerte einstellen
- Temperaturstufen auswählen

Menü Tools:

- Ruhetemperatur einstellen
- Ruhezögerung einstellen (von 0 bis 9 Min. oder kein Ruhezustand)

Menü Tools:

- Standbyverzögerung einstellen (von 0 bis 60 Min. oder kein Standby)

Arbeitsbildschirm

Das HDE-B bietet eine **intuitive Benutzerschnittstelle**, die **schnellen Zugriff** auf die Stationsparameter gewährt.

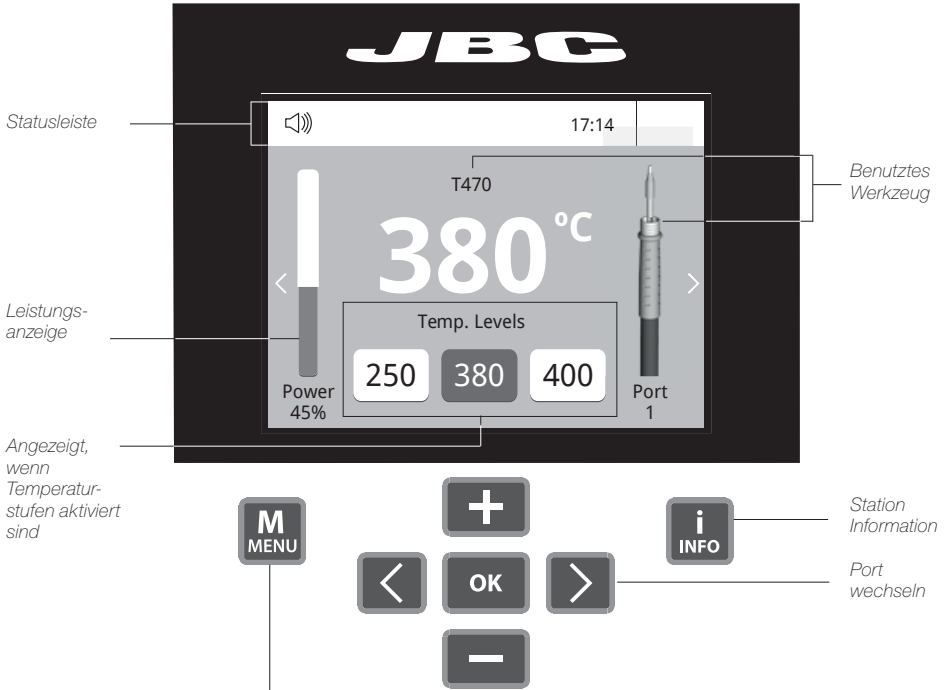

Menüoptionen

Drücken Sie INFO für jede Parameter-Beschreibung.



Station



Werkzeuge



Zähler



Peripheriegeräte



Graphics



Reset

Systemmeldungen (Statusleiste)

- USB-Flashspeicher ist angeschlossen.
- Station wird von einem PC gesteuert.
- Station wird von einem Roboter gesteuert.
- Aktualisierung Stationssoftware.
Drücken Sie INFO, um den Prozess zu starten.
- Warnung.**
Drücken Sie INFO zur Störungsbeschreibung.
- Fehler.** Drücken Sie INFO zur Störungsbeschreibung, des Fehlertyps und empfohlenen Vorgehensweise.

Prozessanalyse



Graphics

Beim Drücken von **Graphics** im Haupt-MENÜ, werden für jeden Port in Echtzeit Temperatur- und Leistungsangaben eingeblendet. Dies hilft Ihnen bei der Entscheidung, welche Spitze Sie für die beste Qualität der Lötverbindungen benutzen müssen.

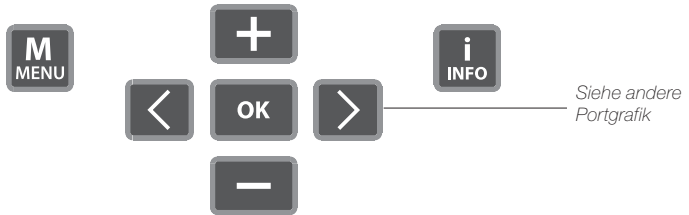
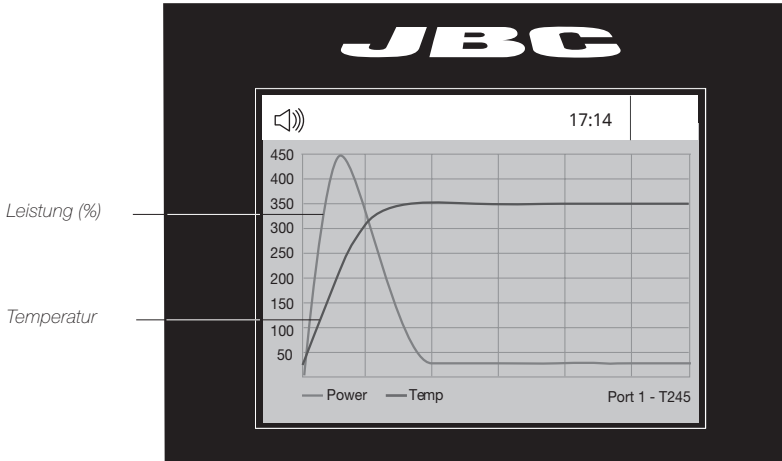

Files



Files

Grafiken exportieren
Stecken Sie einen USB Flashspeicher in den USB-A-Anschluss, um mit dem Speichern Ihres Lötprozesses im csv-Format zu beginnen.



Lötnetz

So viele Stationen, wie Ihr Windows-PC bewältigen kann, aus der Ferne steuern und überwachen.

1. Laden Sie die JBC Manager Software und das Benutzerhandbuch herunter unter www.jbctools.com/manager.html
2. Schließen Sie die Stationen per USB-B-Anschluss an und der PC wird sie automatisch erkennen.
3. Die Meldung  wird auf der Station angezeigt werden.

Funktionen:

- Alle Stationsparameter von Ihrem PC aus einstellen.
- Stationsgruppen organisieren und alle ihre Parameter zur selben Zeit einstellen.
- Spezifische Konfigurationen für spätere Anwendungen speichern.
- Die Lötgrafiken der Stationen auf Ihrem PC analysieren und sie exportieren.

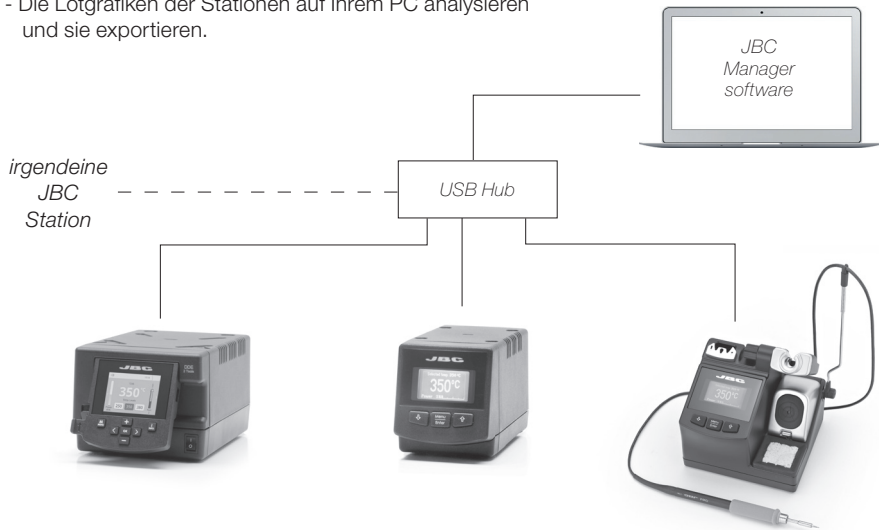

Stationssoftware aktualisieren

1. Laden Sie die JBC Updatedatei herunter unter www.jbctools.com/software.html und speichern Sie sie auf einem USB-Flashspeicher. Möglichst einer ohne andere Dateien.
2. Stecken Sie den USB-Flashspeicher ein. Das Symbol  wird während des Aktualisierens angezeigt.



Arbeit mit Robotern

Verwalten und Monitorüberwachung der Lötstation durch ein Robotersystem.

1. Schließen Sie das Werkzeug mit einem CHB-A Konverter an den Stationsport an.
2. Verbinden Sie Ihr Robotersystem mit der Roboterbuchse (RJ12) der Station.
Sollten Sie bei Bedarf den DB9-RJ12 Stecker benötigen, dieser ist verfügbar unter (Ref. 0013772).
3. Aktivieren Sie die Roberoption in den Stationseinstellungen und die Mitteilung wird angezeigt werden: 
4. Gestalten Sie Ihre Roboter-Befehle gemäß dem Roboter-Kommunikations-Protokoll, verfügbar auf der Website www.jbctools.com/jbcsoftware-menu-115.html.

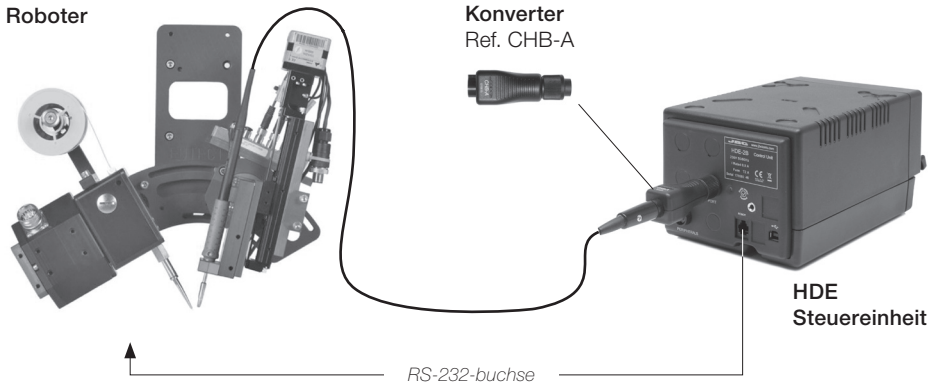

Wartung

Vor der Durchführung von Wartungsarbeiten oder Einlagerung die Geräte immer erst auskühlen lassen.

- Reinigen Sie den Bildschirm der Station mit einem Glasreiniger oder einem feuchten Lappen.
- Benutzen Sie einen feuchten Lappen, um das Gehäuse und das Werkzeug zu reinigen. Alkohol darf nur zur Reinigung der Metallteile benutzt werden.
- Halten Sie die Oberfläche der Spitze vor der Aufbewahrung sauber und verzinkt, um Spitzenoxidation zu vermeiden. Rostige und verschmutzte Oberflächen mindern den Wärmedurchgang zur Lötstelle.
- Überprüfen Sie regelmäßig alle Kabel und Schläuche.
- Eine durchgebrannte Sicherung wie folgt austauschen:



Regelmäßig reinigen

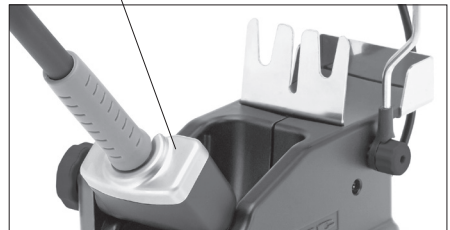

1. Ziehen Sie die Sicherungshalterung heraus und entnehmen Sie die Sicherung. Benutzen Sie bei Bedarf ein Werkzeug, um sie herauszudrücken.

2. Drücken Sie die neue Sicherung in die Halterung und setzen Sie sie erneut in die Station ein.

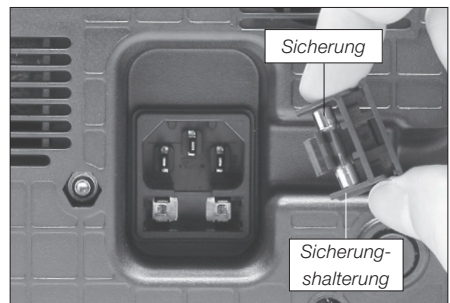
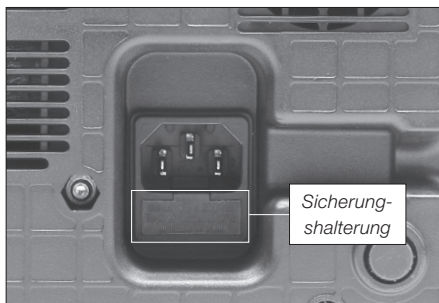

- Jedes defekte oder schadhafte Teil austauschen. Nur Original-Ersatzteile von JBC verwenden.
- Reparaturen dürfen nur von dem Vertragskundendienst von JBC durchgeführt werden.

Sicherheit



Die Sicherheits-Leitlinien müssen unbedingt eingehalten werden, um elektrischen Schlag, Verletzung, Feuer oder Explosion zu vermeiden.

- Die Anlagen für keinen anderen Zweck verwenden als zum Löten oder Entlöten. Unsachgemäße Verwendung kann Feuer hervorrufen.
- Das Netzkabel muss in zugelassene Steckdosen eingesteckt werden. Vergewissern Sie sich vor der Benutzung, dass sie korrekt geerdet ist. Beim Herausziehen am Stecker ziehen, nicht am Kabel.
- Nicht an aktiven Bauteilen arbeiten.
- Das Werkzeug sollte bei Nichtgebrauch in der Ablage abgestellt werden, um die Betriebsart Sleep auszulösen.
Die Lötspitze, der metallische Teil des Werkzeugs und die Ablage können noch heiß sein, wenn die Station ausgeschaltet ist. Gehen Sie vorsichtig vor, sogar wenn Sie die Ständerposition justieren.
- Das eingeschaltete Gerät niemals unbeaufsichtigt lassen.
- Die Kühlungsgitter nicht abdecken. Hitze kann entzündliche Stoffe entzünden.
Ein als "ohne Rückstände" eingestuftes Flussmittel verwenden und die Berührung mit Haut oder Augen vermeiden, um Reizung vorzubeugen.
- Sich vor dem beim Löten entstehenden Rauch in Acht nehmen.
- Ihren Arbeitsplatz sauber und aufgeräumt halten. Bei der Arbeit geeignete Schutzbrille und Handschuhe tragen, um gesundheitliche Schäden zu vermeiden.
- Im Umgang mit flüssigen Zinnrückständen muss äußerste Sorgfalt walten.
- Dieses Gerät kann von Kindern über acht Jahren und auch Personen mit körperlicher, sinnlicher oder geistiger Behinderung oder mangelnder Erfahrung benutzt werden, nachdem ihnen angemessene Überwachung oder Einweisung hinsichtlich der Verwendung des Geräts und der damit verbundenen Risiken gegeben worden ist. Kinder dürfen mit dem Gerät nicht spielen.
- Wartung darf nicht von Kindern durchgeführt werden, wenn sie hierbei nicht beaufsichtigt werden.

Technische Daten

HDE-1B 120V 50/60Hz. Eingangssicherung: 4A. Ausgang: 47V.

HDE-2B 230V 50/60Hz. Eingangssicherung: 2A. Ausgang: 47V.

HDE-9B 100V 50/60Hz. Eingangssicherung: 4A. Ausgang: 47V.

- | | |
|--|---|
| - Gewicht: | 6,1 Kg (13.45 lb) |
| - Abmessungen: | 145 x 120 x 225 mm (5.70 x 4.72 x 8.86 in) |
| - Spitzenausgangsleistung: | 250 W |
| - Temperaturbereich: | 90-500 °C (190-932 °F) (±5%) |
| - Temperaturstabilität (stillstehende Luft): | ±1.5 °C (±3 °F) |
| - Spitze-Erde-Widerstand: | <2 ohms |
| - Spitze-Erde-Spannung: | <2mV RMS |
| - Umgebungsbetriebstemperatur: | 10 - 40 °C (50 - 104 °F) |
| - Connections station-PC | USB / Peripheriegeräteanschlüsse
RJ12-Buchse für Roboter |

Erfüllt EG-Normen

ESD-gerechtes Gehäuse "skin effect"

JBC

www.jbctools.com

大功率焊台

Ref. HDE-B

产品描述

需包含以下部件:

HDE 控制主机 1 件
Ref. HDE-1B (120V)
HDE-2B (230V)
HDE-9B (100V)



支架 1 件
Ref. HD-SD



普通用途HD手柄 1 件
Ref. T470-A



ESD 焊嘴清洁座 1 件
Ref. CL6166



海绵 1 件
Ref. S0354



置放架连接线 1 件
Ref. 0011283



电源线 1 件
Ref. 0010569 (230V)
0013671 (100/120V)



说明书 1 件
Ref. 0016161



连接口

HDE 控制主机

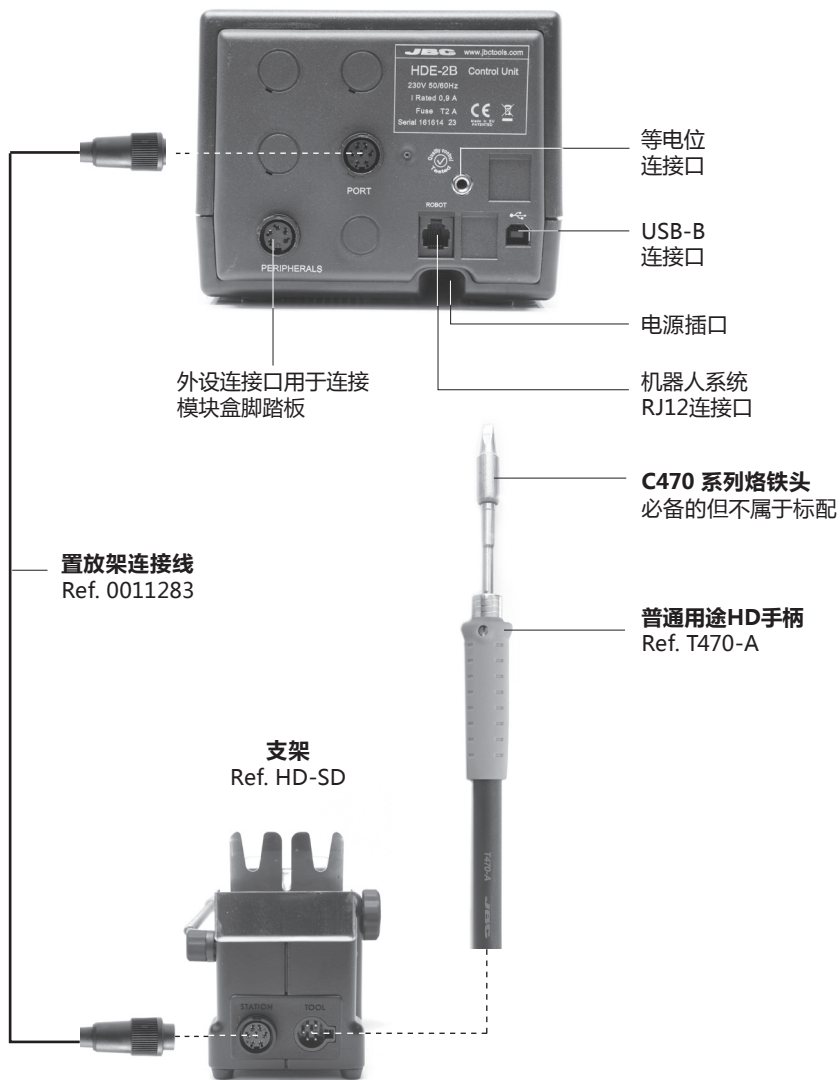

产品特性



性能

根据焊接或拆焊需求选择最适合的设备

控制主机	工具座	工具	烙铁头系列	MNE-A	FSE-A	P-005
HDE-B	HD-SD	T470-A	C470		●	●
		T470-B			●	●
		T470-SA			●	●
		T470-ZA			●	●
		T470-FA			●	●
		T470-MC			●	●
		T470-NA			●	●
	HDT-SD	HT470-A*			●	●
	DN-SE	T470-NA**		●	●	●

* 它可连接两个重负荷焊接工作站,并可单独管理各工作站的烙铁头。

** 需要MNE氮气流量调节器

可调式支架



集线杆

保持工作区域没有线缆的困扰。

快捷焊嘴更换座

烙铁头拔/插系统允许您切换烙铁头且无需中断您的工作。

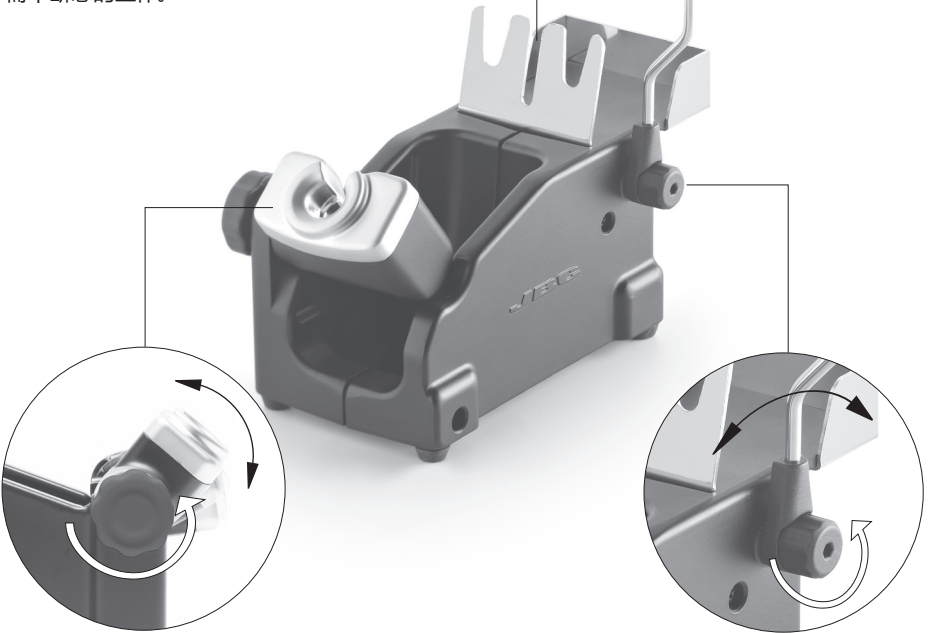

可调节工具支架
适合您的作业习惯。

可调节集线杆

焊嘴清洁座

每个焊点之后清洁焊嘴可改善热传导。

黄铜清洁球

Ref. CL6210

非常有效的清洁方式。在焊嘴表面留下一小层焊锡以防止清洁和再吃锡之间的氧化。

海绵

Ref. S0354

损害最小的清洁方式。工作时用蒸馏水保持海绵湿润以防焊嘴磨损。

防溅罩

使用黄铜清洁球时，最大限度地减少焊料颗粒飞溅。

防滑底座

清洁焊嘴时无需扶住底座。

擦板

Ref. CL0236

一个耐高温托盘可以让操作者通过敲击或擦拭去除多余的焊锡。托盘可以简单拆下并清洗。



敲击
轻轻敲击去除多余的残锡。



擦拭
使用槽口擦拭任何残留的锡粒。

可选

不锈钢清洁球

Ref. CL6205



金属刷

Ref. CL6220

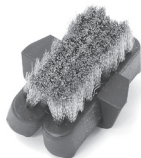

焊嘴还原剂

Ref. TT-A



清洁砂

Ref. CL6211



兼容性工具

重型 T470 手柄

使用 C470 系列来铁头

对于密集型焊接工作时需要持续的高导热能力。其特点是防滑握把具有良好的隔热性能，螺钉用来固定烙铁头，防止打转。

普通用途HD手柄

Ref. T470-A



普通用途HD手柄

Ref. T470-B



普通用途HD手柄，带3米电线

Ref. T470-SA

隔热HD手柄

Ref. T470-FA



隔热HD手柄，带3米电线

Ref. T470-MA

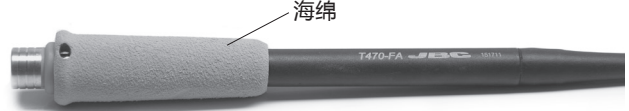

三叶型手柄

Ref. T470-ZA

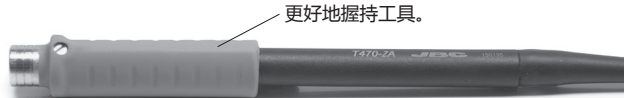

HD 氮气手柄

Ref. T470-NA

T470-NA手柄只和
DN-SE焊台一起使用。



HD 导热镊夹

Ref. HT470-A

HT470-A工具只和两个
HDE-B控制主机和
一个HDT-SD焊台一
起使用。



注意: 所有型号的连接线为1.5米，指定3米线的除外。

更换烙铁头

1. 拔出

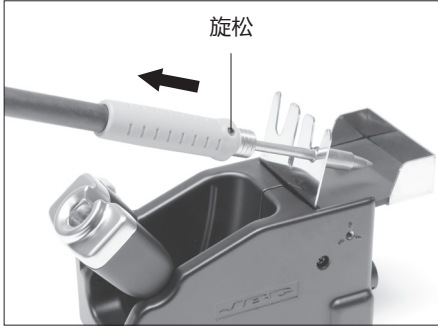

旋松螺母。放置焊笔在插拔座上并拔出烙铁头。

2. 插入

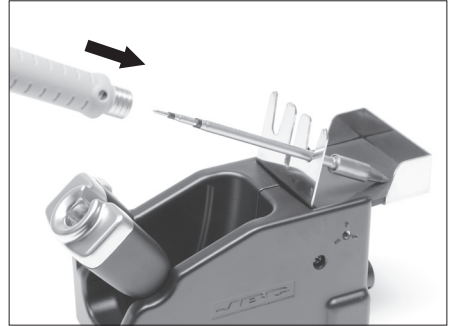

插入烙铁头柄轻轻按紧直至标记处*

3. 固定

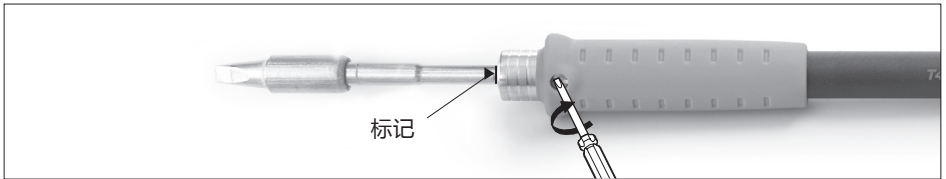

烙铁头正确插入后我们建议拧紧螺丝以防止移动。

***重要提示:** 为了连接良好, 关键是要尽量将烙铁头插入到上面的标记处。

兼容烙铁头

The HDE 使用 C470 系列烙铁头和 T470 手柄。请访问我们的官网 www.jbctools.com 找到最适合您应用的类型。

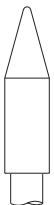

圆头型

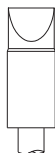

凿型



弯圆头型

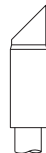

斜面型

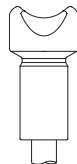

特殊类型

操作

JBC 专属加热系统

革命性技术，可以令烙铁头温度快速回升。
这意味着用户可以在较低温度下操作，并提高焊接质量。
之后，烙铁头温度在睡眠和休眠模式下降低，可令其寿命延长五倍。

1. 工作



当工具从支架取下时，烙铁头温度会加热到选定温度。

2. 睡眠 (Sleep)

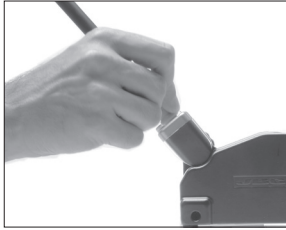

当工具放置在支架上时，温度会下降到预置睡眠温度。

3. 休眠 (Hibernation)

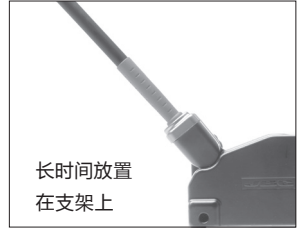

长时间没有使用后，电源会切断，工具会冷却到室温。

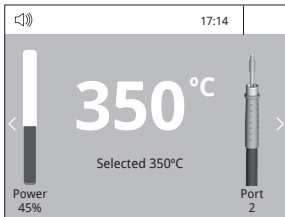

工具菜单：
· 设定温度极限
· 选择温度等级



工具菜单：
· 设定睡眠温度
· 设定睡眠延时
(从 0 至 9 分钟或无睡眠)

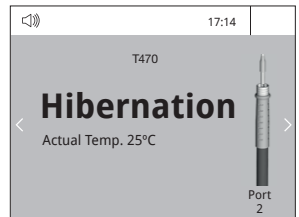

工具菜单：
· 设定休眠延时
(从 0 至 60 分钟或无休眠)

工作屏

HDE 提供了一个直观的用户界面，可以快速访问工作站的参数。

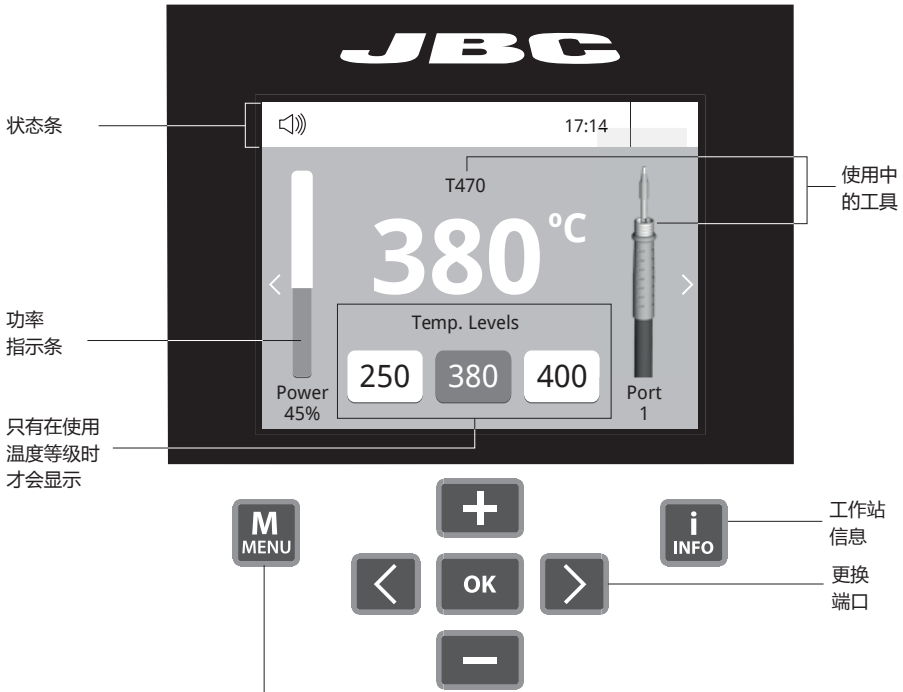

菜单选项

按 INFO 查阅每个参数的说明。



主机



工具



读数表



外设



图形



重置

系统通知 (状态条)

- USB闪存盘已连接。
- 工作站由电脑控制。
- 工作站由机器人控制。
- 工作站软件更新。
按 INFO 启动更新。
- 警告。
按 INFO 查阅故障说明。
- 错误。按 INFO 查阅故障说明，
故障类型，及如何处理。

流程分析



图形

通过按下主菜单上的图形，每个端口响应的实时温度和功率被显示出来。这有助于您决定使用哪种焊嘴来获得最佳的焊接质量。

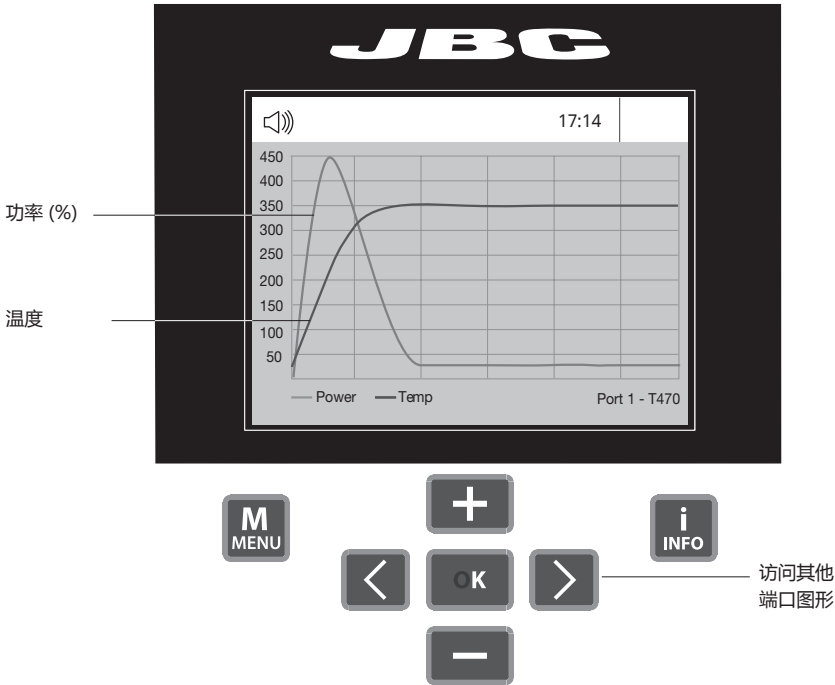

Files



Files

图形导出

插入USB 闪存盘到USB-A 连接口,开始保存您的焊接流程,导出文档为csv格式。



焊接网络

由您的电脑远程管理和监控尽可能多的工作站。

1. 下载 JBC 管理者软件和用户手册, 下载页面 www.jbctools.com/manager.html
2. 工作站连接到 USB-B 接口, 电脑将会自动探测到它们。
3. 通知  将在工作站上显示。

功能说明:

- 从您的电脑上设定所有工作站的参数。
- 创建工作站组群并同时设定它们的参数。
- 保存特定的配置以便以后使用。
- 从您的电脑上分析焊接图形并导出。

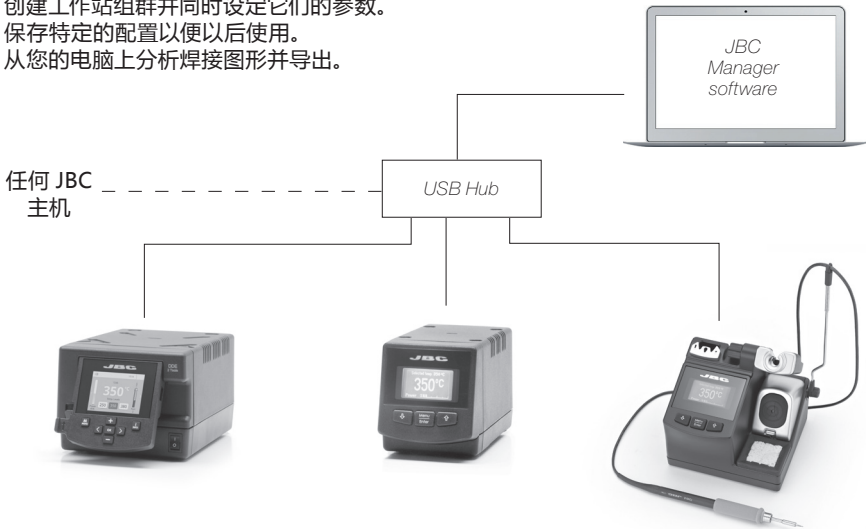

升级工作站软件

1. 下载 JBC 升级文档, 下载页面 www.jbctools.com/software.html, 并保存到 USB 闪存盘。 优选空白闪存盘。
2. 插入 USB 闪存盘。 升级时显示  图标。

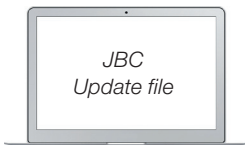

与机器人合作

使用机器人系统管理和监控工作站。

1. 通过转换接头来连接工具到工作站端口。
2. 通过工作站上的(RJ12)机器人接口, 连接您的机器人系统。
DB9-RJ12 适配器仅在必要时提供 (型号 0013772).
3. 在工作站设置中启用机器人选项, 将显示通知: 
4. 根据机器人通讯协议设定您的机器人指令, 可以从以下页面获得

www.jbctools.com/jbcsoftware-menu-115.html.

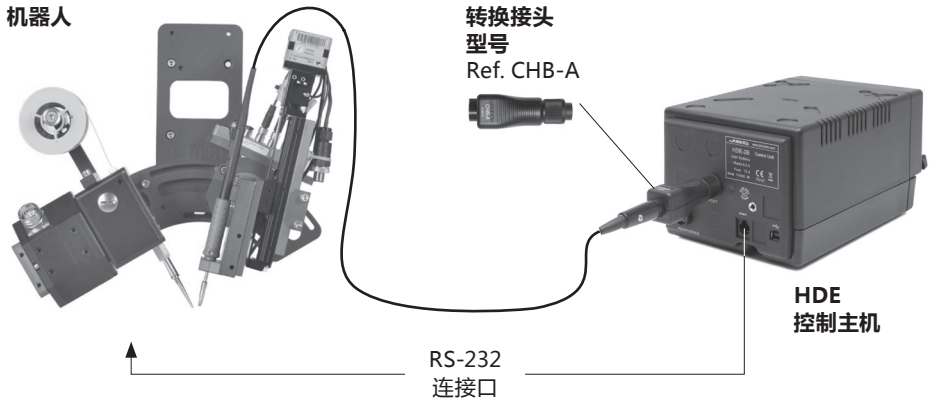

维护保养

在进行维护和存放之前,确认设备已冷却。

- 用玻璃清洁剂或湿布清洁焊台屏幕。
- 用湿布清洁机壳和工具。酒精只能清洁金属部分。
- 定期检查工具和主机的金属部分是否清洁,确保焊台可以检测到工具状态。
- 保持焊嘴表面清洁并在存放前加锡保养以防氧化。生锈和肮脏的表面会减少到焊点的热传递。
- 定期检查所有的电缆连接线和软管。



Clean periodically

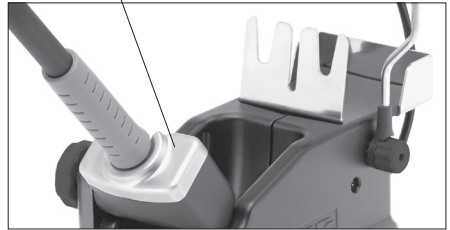

- 更换熔断的保险丝如下:

1. 拔下保险丝托架并取出保险丝。如有必要可使用工具撬动。

2. 按入新保险丝到托架内并放回到工作站。

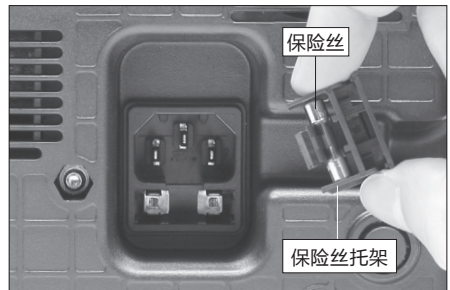

- 更换任何不良或受损件。只可以使用JBC原厂配件。
- 维修只可以由JBC授权的技术服务来执行。

安全



必须遵守安全准则，以防止电击，人身伤害，火灾或爆炸。

- 请勿使用焊台于焊接或返修以外的任何目的。不正当的使用可能引起火灾。
- 电源线必须插入核准的电源。确保在使用前正确接地。拔下时应握住插头而不是电源线。
- 请勿在带电零件上工作。
- 工具不使用时应放在置放架上以激活睡眠模式。
主机关闭后焊嘴，工具和焊台的金属部分可能仍然是热的。请小心处理，哪怕是在调整工作站位置时。
- 设备运行是要始终有人看管。
- 请勿覆盖通风孔。热量可能会导致易燃品点燃。
- 使用“无残留”类助焊剂并避免与皮肤或眼睛接触，以防刺激。
- 小心焊接时产生的烟雾。
- 保持您工作场所的干净整洁。操作时，为避免人身伤害，请穿戴适当的防护眼镜和手套。
- 残锡液易引起灼伤，请小心处理。
- 本产品允许八岁以上儿童，肢体，感官或心智有残缺的人士，以及缺乏经验的人士使用，但必须提供必要的监护及指导，并且了解本产品可能涉及的危险。切勿让儿童把玩。
- 没有监管，儿童不得对本产品进行维护。

技术规格

HDE-1B 120V 50/60Hz. 输入保险丝: 4A. 输出: 47V
HDE-2B 230V 50/60Hz. 输入保险丝: 2A. 输出: 47V
HDE-9B 100V 50/60Hz. 输入保险丝: 4A. 输出: 47V

- 重量: 6,1 Kg (13.45 lb)
- 尺寸: 145 x 120 x 225mm (5.70 x 4.72 x 8.86 in)
- 输出峰值功率: 250W
- 温度范围: 90-500 °C (190-932 °F)
- 待机温度稳定性 (静止空气) ± 1.5 °C (± 3 °F)
- 焊接接地电阻: <2 ohms
- 焊接接地电压: <2mV RMS
- 工作环境温度: 10-40 °C (50-104 °F)
- USB-A / USB-B / 外设接口
- RJ12 机器人接口

符合 CE 标准
ESD 防静电“趋肤效应”保护机壳

Exploded View · Despiece · Explosionszeichnung · 分解图

SPARE PARTS	
HDE-1B / HDE-2B / HDE-9B:	
- REAR CIRCUIT	0018132
- ENCLOSURE	0011035
· TOP	0014587
· BOTTOM	0016313
· FRONT+DISPLAY	0013413
· BACK	

HDE-1B 120V FUSE T-4A
 HDE-2B 230V FUSE T-2A
 HDE-9B 100V FUSE T-5A

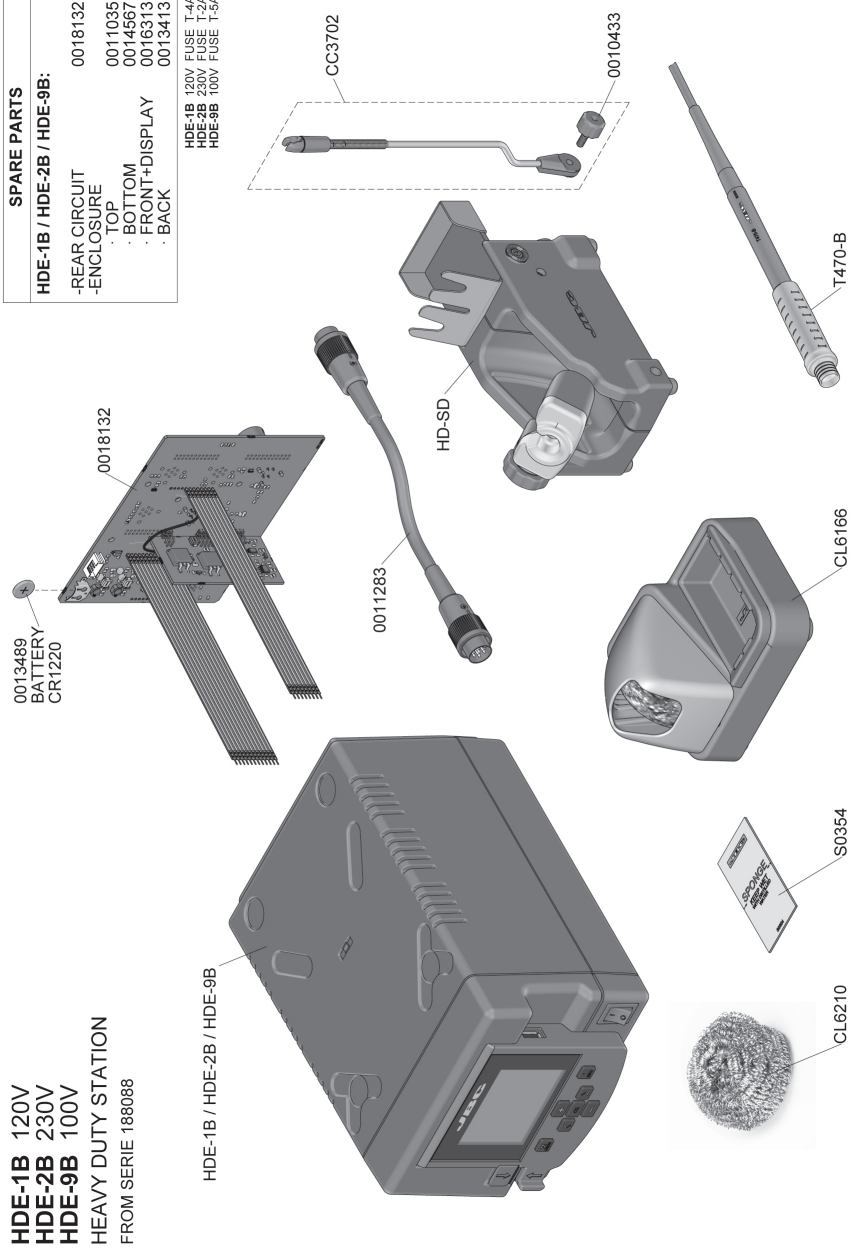

HDE-1B 120V
HDE-2B 230V
HDE-9B 100V
 HEAVY DUTY STATION
 FROM SERIE 188088

HDE-1B / HDE-2B / HDE-9B

Notes

Warranty

JBC's 2 year warranty covers this equipment against all manufacturing defects, including the replacement of defective parts and labour.

Warranty does not cover product wear or misuse.

In order for the warranty to be valid, equipment must be returned, postage paid, to the dealer where it was purchased.

Garantía

Esta garantía de 2 años cubre este equipo contra cualquier defecto de fabricación, incluyendo la sustitución de partes defectuosas y mano de obra.

La garantía no cubre el desgaste del producto por uso o mal uso.

Para que esta garantía sea válida, el equipo debe ser devuelto, a portes pagados, al distribuidor donde se compró.

Garantie

Die 2-Jahres-Garantie von JBC erstreckt sich auf das Gerät bei Herstellungsfehlern, einschließlich Fehlern der Verarbeitung und dem Ersatz defekter Teile und deren Austausch.

Die Garantie gilt nicht für Produktverschleiß durch normale Nutzung oder durch falsche Anwendung.

Damit die Garantie Gültigkeit erlangt, muß das Gerät an den Händler, bei dem es gekauft wurde, zurückgesandt werden (Porto bezahlt).

保修

JBC的2年保修涵盖了该设备所有的制造缺陷，包括更换有缺陷的零件和人工耗时。

保修不包括因过度使用或误用而产生的产品损坏。

为了使保修有效，设备须返还至购买时的经销商处返修，邮资自理。



This product should not be thrown in the garbage.

In accordance with the European directive 2012/19/EU, electronic equipment at the end of their life must be collected and returned to an authorized recycling facility.

Este producto no debe desecharse en la basura.

De acuerdo a la directiva europea 2012/19/UE, los equipos electrónicos al final de su vida se deberán recoger y trasladar a una planta de reciclaje autorizada.

Dieses Produkt sollte nicht mit dem Hausmüll entsorgt werden.

In Übereinstimmung mit der europäischen Richtlinie 2012/19/EU müssen elektronische Geräte am Ende ihrer Lebensdauer eingesammelt und einem autorisierten Recyclingbetrieb zugeführt werden.

本产品不应被扔在垃圾筒内。

根据欧盟条款2012/19/EU，电子设备在其寿命结束后必须被回收并转运至授权回收工厂。