



A Donaldson Company

A WORLD LEADER IN FUME EXTRACTION TECHNOLOGY

# Mobile FumeKART

MECHANICAL ENGINEERING, BEAUTY

Last Updated on 04.01.2019



Multi purpose mobile dust and fume extraction system for a wide range of applications.

The BOFA FumeKART is the ideal portable air extraction and filtration unit and can be applied to a variety of applications.

Designed to filter dust particles, mould spores, solvent vapours and other pollutants from the work environment, the FumeKART is easy to operate and maintain and provides the additional benefit of being fully portable.

The FumeKART mobile fume extractor provides users with flexibility and the assurance of high performance filtration. A filter condition indicator is included as a standard feature, together with three stage filtration: pre filter, HEPA and gas filter.

Ideal for laser applications, hand soldering, jewellery manufacturing, laser hair removal and lots more...

## Technology



DeepPleat pre filter



HEPA filter



Advanced carbon filter technology



Multi voltage sensing unit



ProTECT service plan



SureCHECK quality standard

## Key features of the Mobile FumeKART

Three stage filtration - F8 Pre filter / HEPA / Gas filter  
Standard

Low noise level  
Standard

VOC Sensing (Volatile Organic Compound)  
Optional

Complete with filter condition indicator  
Standard

Digital air flow control  
Standard

Various Arm / Hood Options  
Optional

Contact BOFA at <https://bofainternational.com/en/contact/>

<https://bofainternational.com/en/portal/datasheets/mobile-fumekart/>







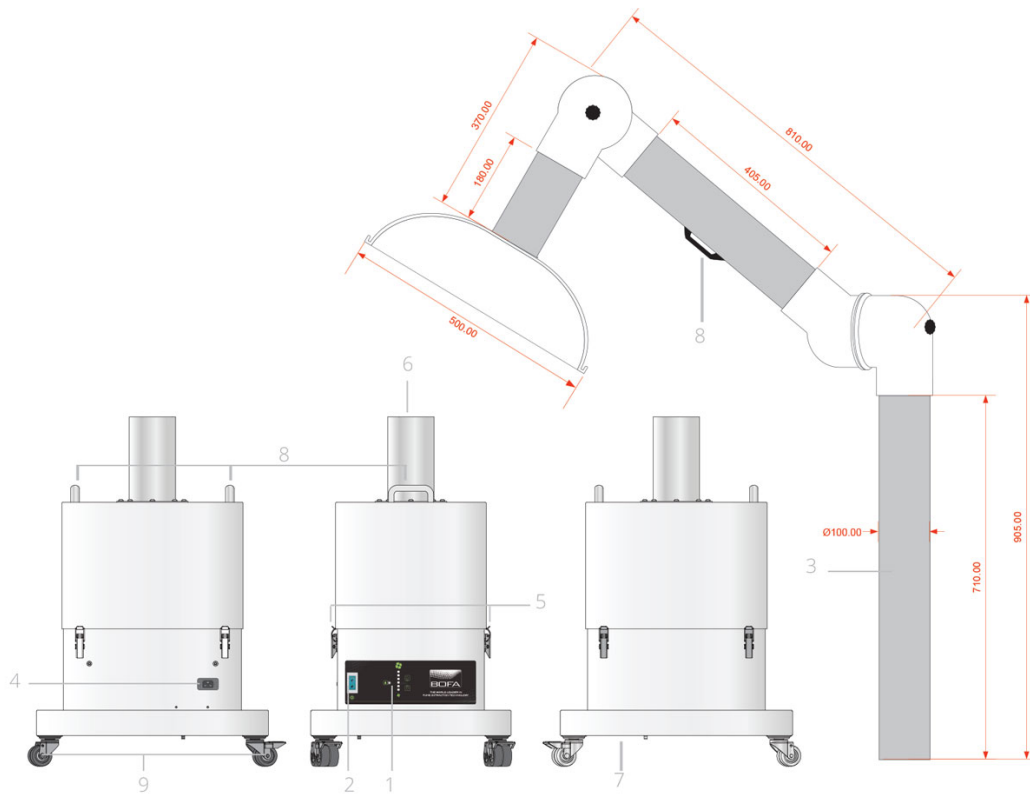

## Technical specification

- 1. Unit / Filter condition display
- 2. On / Off switch
- 3. Extractor arm - 75/100mm
- 4. Power cable inlet
- 5. Filter housing latch
- 6. Hose inlet connection
- 7. Exhaust outlet
- 8. Handle
- 9. Castors



## Airflow through filters

-  Chemical filter
-  HEPA filter
-  Pre filter
-  Clean air
-  Contaminated air
-  Particulate

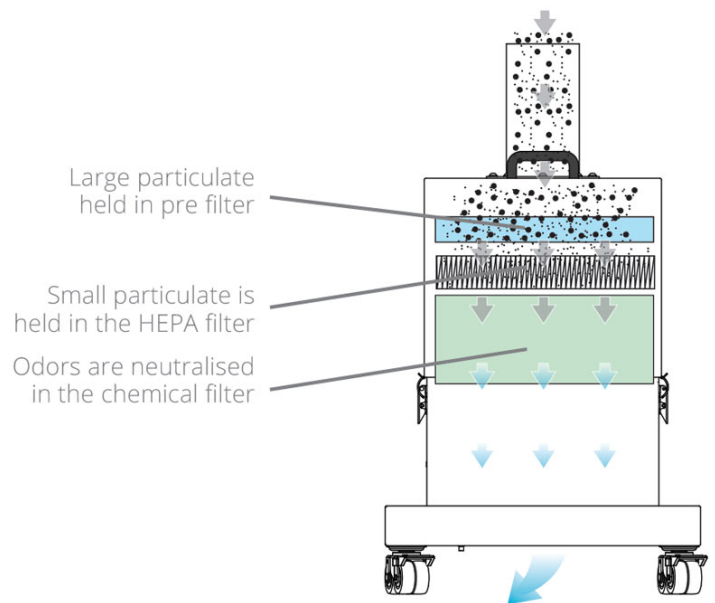

## Technical data

	CE	US
Dimensions (HxWxD)	840 x 475 x 550mm (without arm / spigot)	33.07 x 18.70 x 21.65"
Cabinet construction	Powder coated mild steel	Powder coated mild steel

## Technical data

Blower	Centrifugal turbine	Centrifugal turbine
Airflow	380m <sup>3</sup> /hr	223cfm
Electronics	90 - 257v 1ph 50/60Hz Full load current: 12.5 amps	90 - 257v 1ph 50/60Hz Full load current: 12.5 amps
Noise level	< 64dBA (at typical operating speed)	< 64dBA (at typical operating speed)
Weight	54kg	119lbs
Approvals	CE	CE

## Pre filter specifications

Surface media area	8.25m <sup>2</sup> approx (88.77 ft <sup>2</sup> )
Filter media	Glass fibre
Filter media construction	Maxi pleat
Housing	Cardboard
Filter efficiency	95% @ 0.9 microns

## Combined filter specifications

HEPA filter media	Maxi pleat
HEPA media construction	Maxi pleat construction with webbing spacers
Filter efficiency	99.997% @ 0.3 microns
Surface media area	3.5m <sup>2</sup> (37.66 ft <sup>2</sup> )
Treated activated carbon	12kgs (26.4 lbs)
Filter housing	Zintec mild steel

## Unit part numbers

Model	Arm size	Part number
FumeKART	100mm	L3324A
FumeKART	75mm	L3224A

## Unit option

Description	Feature	Arm Size	Part Number
FumeKART	VOC Monitoring	100mm	L3324A0004
FumeKART	VOC Monitoring	75mm	L3224A0004

## Replacement filters

Description	Part Number
Pre Filter	A1030167
Combined Filter	A1030166

## 75mm Arm Attachments

Description	Part number
75mm Pen Nozzle	A1060150
200mm Funnel	A1020344
420 x 320mm Clear Hood	A1020384
380mm Clear Round Hood	A1080136

## 100mm Arm Attachment

Description	Part Number
380mm Metal Round Hood	A1060151
500mm Clear Round Hood	A1060152

## Hood attachments



500mm clear round hood - 100mm arm attachment



380mm metal round hood - 100mm arm attachment



420 x 320mm clear hood - 75mm arm attachment



380mm clear round hood - 75mm arm attachment



200mm funnel - 75mm arm attachment



75mm pen nozzle - 75mm arm attachment

*Datasheet correct at time of publishing.*

*Where applicable, the carbon used in BOFA units is capable of removing a wide range of VOC's, however it is the responsibility of the user to ensure the carbon is suitable for their application. For specific applications, please contact us for details.*

*Think before you print! Please consider the environment before printing this document.*

